



10-12.08.2023

SUPPLEMENTARY REGULATIONS

INDEX

Art. 1.	Introduction.....	3
Art. 1.1	Preamble.....	3
Art. 1.2	Length of Selective Sections.....	3
Art. 1.3	Overall numbers and total distance of the itinerary.....	3
Art. 1.4	Route terrain on Selective Sections.....	3
Art. 2.	Organisation.....	3
Art. 2.1	Championships and titles for which the Baja counts.....	3
Art. 2.2	Approvals.....	4
Art. 2.3	Organiser's name, address, and contact details.....	4
Art. 2.4	Organising Committee.....	4
Art. 2.5	Stewards of the Meeting.....	4
Art. 2.6	FIA Delegates & Observer.....	4
Art. 2.7	Senior Officials.....	4
Art. 2.8	Location of Rally HQ and contact details.....	5
Art. 3.	Programme in chronological order and locations.....	5
Art. 4.	Entries.....	6
Art. 4.1	Closing date for entries.....	6
Art. 4.2	Entry procedure.....	6
Art. 4.3	Number of competitors accepted and vehicle classes.....	7
Art. 4.4	Entry fees/entry fee packages.....	8
Art. 4.5	Payment.....	8
Art. 4.6	Entry fee refunds.....	8
Art. 5.	Insurance Cover.....	8
Art. 6.	Advertising and Identification.....	9
Art. 6.1	Obligatory organiser's advertising.....	9
Art. 6.2	Optional organiser's advertising.....	9
Art. 7.	Tyres.....	9
Art. 7.1	Regulations regarding tyres which may be used during the event.....	9
Art. 8.	Fuel.....	9
Art. 8.1	Technical Requirements.....	9
Art. 9.	Administrative checks.....	10
Art. 9.1	Documents to be presented:.....	10
Art. 9.2	Timetable.....	10
Art. 10.	Scrutineering, Sealing and Marking.....	10
Art. 10.1	Scrutineering, venue, and time.....	10
Art. 10.2	Drivers' safety equipment.....	11
Art. 10.3	Installation of the Safety Tracking System and Navigation System.....	11
Art. 10.3.4	GPS Data Logger.....	11
Art. 10.3.5	FIA Accident Data Recorder (ADR).....	11
Art. 10.3.6	FIA On-Board Surveillance Camera (FIA OBSC).....	12

Art. 10.4	On-Board Cameras	12
Art. 11.	Other procedures and regulations	12
Art. 11.1	Drivers' Briefing(s).....	12
Art. 11.2	Start Area	12
Art. 11.3	Ceremonial start procedures and order.....	12
Art. 11.4	Electronic start procedure at Selective Sections	12
Art. 11.5	Finish procedures.....	12
Art. 11.6	Permitted early check-in.....	12
Art. 11.7	Official time used during the event.	12
Art. 11.8	Road books delivery.....	12
Art. 11.9	Servicing of vehicles	13
Art. 11.10	Shakedown	13
Art. 11.11	Special procedures and activities.....	14
Art. 12.	Identification of officials.....	15
Art. 13.	Penalties / Classification.....	15
Art. 13.1	Stage / Section Penalties	15
Art. 14.	Prizes.....	15
Art. 15.	Final checks / Protests / Appeals / Fines	15
Art. 15.1	Final Checks	15
Art. 15.2	Protest deposit	15
Art. 15.3	Appeal deposit.....	16
Art. 15.4	Fines	16

Appendix 1	Itinerary
Appendix 2	Names and photographs of the Competitors Relation Officer(s) and their schedules
Appendix 3	Decals and positioning of supplementary advertising.
Appendix 4	Extract from FIA Appendix L relating to overalls, helmets and any other safety requirements.
Appendix 5	Instruction for the use of the Tracking System
Appendix 6	Instructions for the use of the car-to-car communication system
Appendix 7	Items at the organisers' discretion

Art. 1. Introduction

Name of the event: **XX.HunGarian Baja**

Date of the event: 10-12.08.2023.

Art. 1.1 Preamble

This event will be run in compliance with the FIA International Sporting Code (ISC) including appendices, the FIA Cross-Country Rally Sporting Regulations (FIA CCRSR) including appendices, the WADA/NADA Codes, and the FIA Anti-Doping Regulations, as amended from time to time. The National Road Traffic Regulations of the countries the event passes shall apply. Unless provided otherwise by these Supplementary Regulations, the provisions of the above Rules and Regulations shall apply.

Any modifications, amendments and/or additions to the Rules and Regulations shall be made in the form of numbered and dated bulletins. Bulletins will be issued by the Organiser, up to the commencement of administrative checks with the approval of the FIA, after the administrative checks by the Stewards of the Meeting. Exceptionally, modifications to the itinerary may be made by the Organiser. Additional information will be published in the Rally Guide. All FIA regulations can be found at <https://www.fia.com/regulations>.

The various documents will be written in English *and Hungarian*. In case of any discrepancy the English text will be binding.

Art. 1.2 Length of Selective Sections

Stage 1:	221,32	km
Stage 2:	245,60	km
TOTAL	466,92	km

Art. 1.3 Overall numbers and total distance of the itinerary

Number of Stages	2	
Number of Sections	5	
Number of Selective Sections	5	
Total distance of the itinerary	633,37	km

Art. 1.4 Route terrain on Selective Sections.

Gravel/dirt tracks	100	%
Open desert	0	%
Dunes	0	%

Stage 1 Safety Type B

Stage 2 Safety Type B

Art. 2. Organisation

Art. 2.1 Championships and titles for which the Baja counts

FIA European Cup for Cross-Country Bajas

- **European** Cup for Drivers
- **European** Cup for Co-Drivers
- **European** Cup for Teams
- **European** Cup for T2 Drivers
- **European** Cup for T3 Drivers
- **European** Cup for T4 Drivers
- **European** Cup for T4 Teams

FIA Central European Zone Cross Country Rally Championship
Hungarian Cross-Country Rally Championship

Art. 2.2 Approvals

ASN registration number / Visa

Visa No.: K-0378/2023.05.27. Approved on: 27.05.2023

FIA VISA

Visa No.: 03EUBC/230629 Issued on: 29.06.2023

Art. 2.3 Organiser's name, address, and contact details

Organiser: Garilla Racing Kft. and Garzone s.r.o.
Organiser's representative: Zoltán Garamvölgyi
Street/P.O. Box: Házgyári str.1.
Post code/city: 8200 / Veszprém
Phone and fax: +3630 696 0386
E-mail: info@hungarianbaja.com

Art. 2.4 Organising Committee

Organising Committee: Mr. Zoltán GARAMVÖLGYI
Mrs. Márta CAMPANARI-TALABÉR
Mr. László POLGÁR
Mrs. Zsófia CSŐVÁRI

Art. 2.5 Stewards of the Meeting

	Name	License no.
Stewards of the Meeting (Chairperson):	<i>Mr. Wilhelm SINGER</i>	FIA-STW-017-000 127
2 nd FIA Steward	<i>Mr. Wolfgang GASTORFER</i>	FIA-STW-019-000109
ASN Steward	Mr. Attila VINOCZAI	10033

Art. 2.6 FIA Delegates & Observer

	Name
FIA Observer	<i>Mr. Wolfgang GASTORFER</i>
FIA Technical Delegate	<i>Mr. Janez FLERIN</i>

Art. 2.7 Senior Officials

	Name	License no.
Event Director:	Mr. Zoltán GARAMVÖLGYI	
Clerk of the Course:	Mr. Péter FALUVÉGI	10012
Deputy Clerk of the Course:	Mr. Dávid MAJOR	3787
Secretary of the Event:	Ms. Julianna TÖRÖK	
Chief Safety Officer:	Mr. Sándor NÉMETH	
Deputy Chief Safety Officer:	Mr. Ferenc SCHEIBENHOFFER	
Scrutineers (Chief Scrutineer):	Mr. Szabolcs SOLTI	11139
Scrutineer	Mr. Tibor SZABADOS	11045
Scrutineer	Mr. István Kőszegi	11016
Scrutineer	Mr. Bálint Hepp	11163
Chief Medical Officer (CMO):	Mr. Zoltán PÁLL	
Timekeeping (Chief Timekeeper):	Mr Csaba GLÜCK	2049

Competitors' Relations Officer (CRO):	Mr. István MÁTRAI	
Results	Mr. Csaba GLÜCK	
Press Officer:	Ms. Anita TÓTH	
Environmental Officer:	Mr. Péter BAKÓ	

Art. 2.8 Location of Rally HQ and contact details

Name: Thury Castle
Street: Hunyadi Mátyás Square 1.
Post code, city: Várpalota
Phone and fax: +36 88 472 305
E-mail: info@hungarianbaja.com

Rally HQ in operation: from 10.08.2023 7:00 to 12.08.2023. 19:00

Service parc in operation: from 10.08.2023 7:00 to 12.08.2023 22:00

The Official Notice Board will be the Digital Notice Board (DNB):

Sportity, www.chronomoto.hu, www.hungarianbaja.com,



On PC: https://webapp.sportity.com/channel/HGB23_FIA

Art. 3. Programme in chronological order and locations

Date:	Time:		Location:
01.06.2023	10:00	Publishing of the supplementary regulations	
01.06.2023	10:00	Entries open	www.hungarianbaja.com
07.06.2023	16:00	Issuing of Rally Guide	
10.07.2023	24:00	Closure date of entries at reduced fees	www.hungarianbaja.com
27.07.2023	24:00	Closure date of entries	
27.07.2023	24:00	Closing date for order of extra service in SP	info@hungarianbaja.com
27.07.2023	24:00	Closing date for shakedown registration	
02.08.2023	16:00	Publication date of entry list	Sportity, www.hungarianbaja.com
02.08.2023	10:00	Press conference before the rally	Thury Castle, Várpalota
09.08.2023	16:00-20:00	Registration, Check List and Service Plate delivery	TESCO, Várpalota
10.08.2023	07:00-18:00	Registration, Check List and Service Plate delivery	TESCO, Várpalota
10.08.2023	08:00-15:00	Administrative checks	Thury Castle, Várpalota
10.08.2023	08:00	Collection of material and documents	Thury Castle, Várpalota
10.08.2023	08:00	Collection of rally safety tracking system	Thury Castle, Várpalota

10.08.2023	08:00	Collection of navigation GPS (NAV-GPS)	Thury Castle, Várpalota
10.08.2023	09:00-16:00	Scrutineering – sealing & marking of components	TESCO, Várpalota
10.08.2023	08:00	Opening of media centre	Thury Castle, Várpalota
10.08.2023	17:00-18:00	Re-scrutineering for car which did not pass	TESCO, Várpalota
10.08.2023	11:00-16:00	Shakedown	Várpalota, according to Shakedown Roadbook
10.08.2023	15:00-18:30	Parc-Fermé	VÁRPALOTA FŐTÉR Szabadság Square
10.08.2023	18:00	Team managers and/or Drivers' briefing	Thury Castle, Várpalota
10.08.2023	18:00	Issuing of the road book (Stage 1), maps	
10.08.2023	19:00	Publication of start list for Ceremonial Start	DNB
10.08.2023	19:00	Publication of list of cars eligible to start	DNB
10.08.2023	19:00	Publication of start list for Stage 1	DNB
10.08.2023	20:00	Ceremonial Start	Thury Castle, Várpalota
11.08.2023	08:00	Start of the Rally – Stage 1, Section 1 (TC0) Prologue	Thury Castle, Várpalota
11.08.2023	09:23	Finish of Section 1 (estimated time of 1 st car)	Thury Castle, Várpalota
11.08.2023	11:00	Selection of Starting Position after Prologue	Thury Castle, Várpalota
11.08.2023	11:30	Publication of start list for Stage 1, Section 2	DNB
11.08.2023	11:30- 12:00	Re-scrutineering, cars to re-start after retirement	TESCO, Várpalota
11.08.2023	12:00	Start of Stage 1, Section 2 (estimated time of 1 st car)	Thury Castle, Várpalota
11.08.2023	20:13	Finish of Stage 1 (estimated time of 1 st car)	Thury Castle, Várpalota
11.08.2023	22:30	Publication of start list for Stage 2	DNB
12.08.2023	09:00	Re-scrutineering, cars to re-start after retirement	TESCO, Várpalota
12.08.2023	10:00	Start Stage 2 (estimated time of 1 st car)	Thury Castle, Várpalota
12.08.2023	17:13	Finish of Stage 2 (estimated time of 1 st car)	Thury Castle, Várpalota
12.08.2023	17:30	Final scrutineering; Immediate after arrival in the finish (following the marshals' instructions)	MÁRIA GUMI, Várpalota
12.08.2023	18:30	Publication of Provisional Classification	DNB
12.08.2023	19:00	Publication of Final Classification. After the Stewards have declared the Classification final	DNB
12.08.2023	19:00	Podiums Ceremony / Prize-giving	Thury Castle, Várpalota

Art. 4. Entries

Art. 4.1 Closing date for entries

See programme in chronological order (SR Art. 3) and FIA CCRSR Art. 17

Art. 4.2 Entry procedure

Entries must be submitted in accordance with the FIA CCRSR Art. 16 – Art. 18.

See also FIA International Sporting Code Art. 3.8 – Art. 3.14

An electronic entry application (Internet) will be accepted on the organisers' website www.hungarianbaja.com. If the application is sent by email **or** made electronically, the original duly signed entry form must reach the organisers within 5 days following the close of entries.

The entry form must be accompanied by a copy of the valid competitor's licence. If one of the drivers will be the competitor, he must hold a valid a competitor's licence and a driver's competition licence.

Mailing address for entry form:

Name: Garilla Racing Kft.
Street: Házgyári str.1.
Post code/city: 8200 Veszprém
E-mail: julianna@hungarianbaja.com

An entry application (also made electronically) will be accepted only if accompanied by the total entry fees. The entry fee must be credited in full to the organiser's bank account:

Slovenská Sporiteľna, a.s.	Garzone s.r.o.
Bank	Account holder
SK2609000000005063476359	GIBASKBX
IBAN	BIC

There is no registration with the FIA to the European Cup for Cross-Country Bajas.
Teams classifications are restricted to juridical persons.
For further information, please refer to V3, Art. 3.6 of the FIACCRSR.

Art. 4.3 Number of competitors accepted and vehicle classes

Art. 4.3.1 The number of competitors shall be limited to: 60

The minimum number of entered automobiles required is.: 20
If that number is not reached, the Organiser may cancel the competition after obtaining the FIA's approval."

Art. 4.3.2 Eligible cars

- **Group T1:** Prototype Cross-Country Vehicles.
- **Group T2:** Series Production Cross-Country Vehicles.
- **Group T3:** Lightweight Prototype Cross-Country Vehicles.
- **Group T4:** Modified Production Cross-Country Side-by-Side Vehicles.

Art. 4.3.3 Groups/Classes of vehicles

Group	Class	Vehicle
T1	T1+	Prototype Cross-Country Vehicles 4x4 complying with Appendix J, Art. 285-11
	T1.1	Prototype Cross-Country Vehicles 4x4 complying with Appendix J, Art. 285
		Prototype Cross-Country Vehicles 4x4 complying with 2009 Appendix J, Art. 285 (see Art. 8.4)
T1	T1.2	Prototype Cross-Country Vehicles 4x2 complying with Appendix J, Art. 285
		Prototype Cross-Country Vehicles 4x2 complying with 2009 Appendix J, Art. 285 (see Art. 8.4)
	T1.3	Vehicles complying with "SCORE" regulations (see Art. 8.5)
	T1.4	Series Production Cross-Country Vehicles with expired homologation, complying with Appendix J, Art. 284 (see Art. 8.6.1)
T2		Series Production Cross-Country Cars complying with Appendix J, Art. 284
T3	T3.U	"Ultimate" lightweight Prototype Cross-Country Vehicles complying with Appendix J, Art. 286-14
	T3.1	Lightweight Prototype Cross-Country Vehicles complying with Appendix J, Art. 286
T4		Modified Production Cross-Country Side-by-Side (SSV) Vehicles complying with Appendix J, Art. 286A

See also FIA CCRSR Art. 8 for additional provisions

Art. 4.4 Entry fees/entry fee packages

With organiser's optional advertising (see also FIA CCRSR Art. 20)

EUR 2.200	up to 10.07.2023. 24:00
EUR 2.650	up to 27.07.2023. 24:00

Without organiser's optional advertising: (see also FIA RRSR Art. 20)

EUR 4.000	up to 10.07.2023. 24:00
EUR 4.300	up to 24.07.2023. 24:00

Service Area Fees: Each competition vehicle is entitled for up to 50sq.m. space in Service Park and fee for this space is included in Entry Fee.

Additional fees:

EUR 200	Additional set of service documents +50sq.m and +1 service sticker to the service car
EUR 200	Team entry
EUR 200	Shakedown
EUR 100	Waterproof Road Book
EUR 80	GPS Installation KIT

Art. 4.5 Payment

Any entry not accompanied by the entry fee shall be, according to Art. 3.9.3 of FIA International Sporting Code, null and void. The entry fee shall be paid by cheque attached to the entry form or by bank transfer to the account indicated below (in the latter case, adequate proof of payment must be attached to the entry form):

Organiser's bank details:

Slovenská Sporitelna, a.s.	Garzone s.r.o.
Bank	Account holder
SK2609000000005063476359	GIBASKBX
IBAN	BIC

Art. 4.6 Entry fee refunds

The entry fee shall be refunded in full:

- if the event does not take place
- to teams whose entry application is rejected.

The organiser may partially refund entry fees if a competitor cannot take part in the event due to a duly proved case of force majeure.

Art. 5. Insurance Cover

Name of the insurance company: SRC SPECIAL RISK CONSORTIUM GMBH, Kuniberts kloster 7-9, D 50668 KÖLN.

The limit of the responsibility is 3.000.000 Eur.

- In case of an accident leading to insurance event, the competitor or his representative must make a written statement to the Clerk of the Course, the Competitors Relations Officer, or directly to the Organizer, within 24 hours. This statement must mention the accident circumstances, the names and addresses of the casualties, as well as contact details of the witnesses.
- Competitors are reminded that only damage caused by the organizers and named drivers are covered by the Organization's insurance policy. Loss or injury that may be suffered by the drivers themselves or participating vehicles is EXCLUDED.

- Irrespective of this Third Party insurance, entrants and drivers are free to take out the policies they deem fit on their own account and at their own discretion.
- Service vehicles, including those displaying the plates supplied by the Organization, shall under no circumstances be deemed participating vehicles. They are therefore not covered by the Organization's insurance policy and responsibility for them lies solely with their owners.
- The insurance cover will come into effect from the administrative checking and scrutineering for the Event and end upon the expiry of one of the following time limits, whichever is the later:
 - time limit for protests or appeals or the end of any hearing by the Stewards;
 - end of the administrative checking and postevent scrutineering;
 - end of the prize-giving.

The Organization refuses all responsibility stemming from the consequences of infractions of the law, regulations and decrees of Hungary, committed by Competitors or their service crew, which must be exclusively borne by them.

Art. 6. Advertising and Identification

See Appendix 3 of these SR "Decals and positioning of supplementary advertising".

The organiser will provide each crew with the advertising and identification panels, which must be affixed to their vehicles in the stated positions prior to scrutineering. **It is not allowed to cut the panels.**

Art. 6.1 Obligatory organiser's advertising

Rally plate:

XX.Hungarian Baja

Competition number size: 67 x 17 cm

Will be published in a Bulletin

Each panel shall be placed horizontally at the leading edge of each front door, with the number at the front. The top of the plate shall be between 7 cm and 10 cm below the lower limit of the window.

Competition number size (roof panels): **50 x 52 cm**

Will be published in a Bulletin

Art. 6.2 Optional organiser's advertising

Additional organiser's advertising:

Will be published in a Bulletin

Size: 50x50cm, for T3, T4: 30x30cm

Spaces on the vehicle that must be kept free:

All plates shall be placed as one uncut piece on vehicle's position indicated on Appendix 3 of present SR, Cut is permitted in T3, T4, vehicles only due to lack of such substantial space in the cars' surface.

Art. 7. Tyres

Art. 7.1 Regulations regarding tyres which may be used during the event

See Art. 10 of the FIA CCRSR and Art. 10 of Appendix V2 of the FIA CCRSR

The number of tyres to be used by FIA T1 Priority drivers is **12**.

Art. 8. Fuel

All type of fuel must follow Appendix J Art. 252.9. (Art. 56 of the FIA CCRSR).

Art. 8.1 Technical Requirements

See Art. 56.2 of the FIA CCRSR (Refuel Couplings)

Art. 9. Administrative checks

Before the Administrative Check, each crew must **Register** at Tesco parking lot (Fehérvári str.17.), where the Service stickers and Checklist will be provided.

To minimize the time required for administrative check, please make a photo or scan copies of the documents required, and send them to the following email address: julianna@hungarianbaja.com.

Art. 9.1 Documents to be presented:

(see Art. 22 of the FIA CCSR)

To keep the time required for the administrative checks to the necessary minimum, make sure to bring and present the following documents:

- Competitors' licence
- Driver's and co-driver's competition licences (if one of the drivers should be the competitor, he must hold also a competitors' licence)
- Driver's and co-driver's ID cards/passports
- Driver's and co-driver's valid driving licences valid for the vehicle entered.
- ASN authorisation for foreign competitors (if required)
- Completion of all details on the entry form
- Car registration papers
- Competing vehicle's insurance cover

Art. 9.2 Timetable

See programme (SR Art. 3)

Individual times for each competitor for the administrative checks will be published on Sportity and www.hungarianbaja.com in a Bulletin.

A time control before the Administrative Checks (C1) will be arranged, according to the individualized timetable.

Any delay to the C1 control will be penalized as follows:

- From 1 to 15 minutes: 150€ fine
- From 16 to 30 minutes: 250€ fine
- From 31 to 60 minutes: 500€ fine
- More than 60 minutes: 500€ fine and report to the Stewards.

Art. 10. Scrutineering, Sealing and Marking

See Article 23 and Article 24 of the FIA CCSR.

After Scrutineering, the Parc Fermé is mandatory for all cars which have passed scrutineering.

(Time: 10.08.2023 15:00-18:30, Location: VÁRPALOTA FŐTÉR, Szabadság Square)

Art. 10.1 Scrutineering, venue, and time

Cars may be presented at scrutineering by a representative of the team. See programme (SR Art. 3)

Location: VÁRPALOTA TESCO, Fehérvári str.17.

Art. 10.1.1 Scrutineering, mandatory documents

- Cars' complete original FIA Homologation Document (if applicable)
- FIA Technical Passport
- SOS / OK board (DIN A3 format)

The installation of the tracking system and the NAV-GPS will be checked at scrutineering.

The complete original FIA homologation form / FIA Technical Passport and all other necessary certifications/documents must be available for final checks.

Art. 10.1.2 Timetable for scrutineering

See programme (SR Art. 3)

Individual times for each competitor for the Technical Scrutineering will be published on Sportity and www.hungarianbaja.com in a Bulletin.

There will be a time control before the Scrutineering (C2). The competitors should check-in to this time control according the individual schedule.

Any delay to the C2 control will be penalized as follows:

- From 1 to 15 minutes: 150€ fine
- From 16 to 30 minutes: 250€ fine
- From 31 to 60 minutes: 500€ fine
- More than 60 minutes: 500€ fine and report to the Stewards.

Art. 10.2 Drivers' safety equipment

All items of clothing including helmets and FHR (Front Head Restraint) intended to be used, e.g. HANS devices, must be presented for scrutineering. They shall be checked for compliance with Appendix L, Chapter III.

The cars must be equipped with the medical kit according to FIA CCRSR Appendix IV-1 and FIA Technical List n°83 and the survival kit according to FIA CCRSR Appendix IV-2.1 and the defined Safety Type (see SR Art. 1.5).

Art. 10.3 Installation of the Safety Tracking System and Navigation System

Art. 10.3.1 Safety Tracking System (FIA CCRSR Art. 12.1)

All vehicles must **only** be fitted with the Safety Tracking System(s) provided by the Organiser. The instruction for the use of the Tracking System is in the Appendix 5 of these Supplementary Regulations.

The system will be collected either by the crew or a representative and must be installed before the car is brought to scrutineering. All the damage caused for the rally safety tracking equipment will be invoiced afterwards. Returning will be at the entrance of Parc Ferme on Saturday, 12th August or at Rally HQ Secretary in case of retirement.

Art. 10.3.2 Navigation System (NAV-GPS)

Navigation System (NAV-GPS – FIA CCR SR Art. 12.2)) The Safety Tracking System(s) provided by the Organiser have included in it the waypoints (WPP) defined by the Organiser as established in art. 11.11.3 of the Supplementary Regulations.

Art. 10.3.3 Connection of the Systems (FIA CCRSR Art. 12.3)

The specifications for the standard power connector are laid down in the FIA CCRSR Appendix VI. It is the competitor's responsibility to ensure that the Safety Tracking System(s) and the NAV-GPS always remain permanently connected and switched on with the antenna connected throughout the duration of the competition.

Art. 10.3.4 GPS Data Logger

Vehicles selected by the FIA after the publication of the entry list may be equipped with a GPS Data Logger to monitor their performances during the event.
See FIA CCRSR Article 13.1.

Art. 10.3.5 FIA Accident Data Recorder (ADR)

(See Appendix J, Article 283-2, Accident Data Recorder)

An Accident Data Recorder (ADR) complying with FIA Standard 8872-2018 "Accident Data Recorder" (listed in Technical List no. 88) must be installed in T1 cars manufactured from 2016 that participate in any Championship event. The ADR must be installed in accordance with the FIA ADR Installation Specification and manufacturer user's manual.

Art. 10.3.6 FIA On-Board Surveillance Camera (FIA OBSC)

Vehicles selected by the FIA may be equipped with an FIA OBSC to monitor all activities inside the vehicle during the event.

Art. 10.4 On-Board Cameras

See FIA CCRSR Article 11.

The request for the On-Board cameras must be indicated on the Entry Form and installed prior to the Technical Scrutineering, where it will be checked and identified by an adhesive decal provided by the Organiser (see Art. 11.2 of the FIA CCRSR).

Art. 10.5 Electronic Equipment

Any radio or electronic means of communication, or any other device not expressly permitted in FIA CCRSR regulations is forbidden on board the vehicles.

Art. 11. Other procedures and regulations

Art. 11.1 Drivers' Briefing(s)

See programme (SR Art. 3)

The participation of at least one crew member is compulsory.

Art. 11.2 Start Area

There will be no pre-starting area organized. Competitors have to present themselves, along with their competition vehicles, to the first Time Control of the race (TC 0, see Appendix 1 of Itinerary) according to the Starting List and relevant time that will be communicated via DNB.

Art. 11.3 Ceremonial start procedures and order

On Thursday evening, everyone will exit from the Parc Fermé to the Starting Ceremony, based on the issued Start List. It is mandatory to return to the Parc Fermé afterwards.

Art. 11.4 Electronic start procedure at Selective Sections

The start of the selective section is happening based on an electric clock and lamp, connected to a false start alert system.

When the car arrives at the start line, the front of the car should be positioned behind a stick placed by the marshal to define the exact start position. One minute before the start time, but not before the car has stopped in its exact position, the marshal shall remove the stick and the crew shall refer to the automatic countdown clock. Any subsequent change of the car's position until its start time is not permitted and will be reported to the Stewards.

Art. 11.5 Finish procedures

At the end of Stage2, the crews must place the vehicles in Parc Fermé, located in Várpalota Fő tér, Szabadság square, according time schedule of the event on Saturday, 12th August.

Art. 11.6 Permitted early check-in.

Early-check in is allowed at TC2C and TC4A

Art. 11.7 Official time used during the event.

The official time is the GPS time. (GMT+1)

Art. 11.8 Road books delivery

The Organiser will issue coloured, printed Road Book as follows (See also program (SR Art. 3):

- At Administrative Checks: Road Book for Shakedown Stage.
- At Briefing: Road Book for Stage1: 18:00
- Entering Park Fermé at the end of Stage1: Road Book for Stage2

Competitors are noticed that all notes in all Road Books of any STAGE provided by the Organiser are considered as Waypoints. Competitors are advised to use a GPS-tripmeter in compliance with Art.12.4 of 2023 CCRSR.

Art. 11.9 Servicing of vehicles

Art. 11.9.1 Service Areas / Bivouacs

Access to the Service Park will only be permitted for vehicles, accompanying team cars- showing the Service Stickers, provided by the Organizer at the Registration (Tesco parking lot, Fehérvári str.17.) 1pc Service sticker/team is provided by the Organizer.

Tampering with or falsification of these stickers will lead to disqualification of the team to which these service vehicles belong, on the decision of the Stewards. The stickers will be placed in a visible area inside of the front windscreen of the vehicle.

Car wash and Refuelling is strongly prohibited in the total area of the service park!!! The only possibility to wash the cars is in the official car wash company, just beside the service park.

The speed of vehicles in the service parks/bivouacs may not exceed **20 kph**

From TC0 onwards, service of a competing car may be carried out in Service Areas (Service Parks and Bivouacs) and road sections as permitted under the FIA CCRSR.

Art. 11.9.2 Identification of team personnel

In service areas, after the start of the competition, only 3 team personnel may work on a competing vehicle. They will be identified by distinctive armbands.

Art. 11.9.3 Service allowed in Selective Section

In accordance with article 49 of the FIA CCR SR, any service is forbidden during Selective Sections. Only crews with FIA groups vehicles still in the competition for the current Stage/SS may assist each other.

Art. 11.9.4 Flexi Service

Not applicable.

Art. 11.9.5 Fuel and Refuelling Zone

Refuelling is permitted only in commercial fuel stations using fuel on sale to the public. Only the crew may carry out this procedure.

The Refuelling station authorised will be indicated in the Road Book with "FUEL STATION".

Type of fuel available at the filling stations

- Diesel
- Diesel Premium
- Petrol 95
- Petrol 100Plus.

No additional refueling zone will be established.

Art. 11.9.6 Tyre Fitting Zone

Not applicable

Art. 11.10 Shakedown

01. 06. 2023. Tuesday	Opening date for shakedown's entries
27. 07. 2023 Monday	Closing date for shakedown's entries
10. 08. 2023 Thursday	Delivery Shakedown's materials (Identification plates – Road Book)

10.08 2023 Thursday **11:00 to 16:00** **Shakedown** Length: 4km

ENTRY PROCEDURE:

Anybody wishing to perform the Shakedown must indicate on the Entry Form, or inform the secretariat of the event via email: info@hungarianbaja.com

REGISTRATION FEE FOR SHAKEDOWN

2 hours / vehicle	€ 200,00
-------------------	----------

The price includes:

- VAT 27%
- Insurance
- SHAKEDOWN Road Book
- SHAKEDOWN sticker
- Rescue and Medical preparedness

CONDITIONS TO PARTICIPATE:

- Driver and co-driver must be registered in the Entry Form of HunGarian Baja 2023;
- The vehicle must be the one indicated in the entry form of HunGarian Baja 2023;
- The vehicles must have passed the pre-event scrutineering
- The shakedown fee must be paid;

To participate at the Shakedown, all identification and advertising panels received at the administrative check, including the Shakedown sticker (1 strip 25 cm x 10 cm to the centre top of the windscreen) must be affixed to the racing vehicle.

SERVICE AREA: Close to the Shakedown zone, the Organiser will provide an area where it will be possible to service on the race vehicles.

RUNNING OF THE SHAKEDOWN

Inside the race car, the competitors must wear FIA homologated clothing and equipment, in accordance with Appendix L.

All vehicles will start with an interval of 2 minutes: the starting order will be based on the arrival to the preset zone and can perform as many laps as they wish in two hours.

After the Shakedown, participants must put their cars in the Parc Fermé 15:00-18:30 10.08.2023.

Art. 11.11 Special procedures and activities

Art. 11.11.1 Availability of participants

Participants who park their vehicles in the Parc Fermé upon passing the finish line, must remain available by phone (mobile) until the final classification have been posted.

Art. 11.11.2 Classification

The final classification will not be distributed after the event. The final classification will be published on the website on the Digital Notice Board: Sportity, www.chronomoto.hu, hugarianbaja.com.

Art.11.11.3 Electronic Control of Itinerary

According with article 14.2.1 of 2023 FIA CCR SR the itinerary of the event is defined in the Road Book by the road direction diagrams. ALL the diagrams of the Road Book will be considered as a PRECISE WAYPOINT (WPP) as defined by art. 43.7 of 2023 FIA CCR SR with a validation radius of 20 meters as established in table of art. 43.1.6 of 2023 FIA CCR SR: According with article 14.2 of 2023 FIA CCR SR, the observance of the road book and the road direction diagrams will be electronically controlled and these information are contained in the memory of the GPS tracking system provided by the organiser according article 12.1 of 2023 FIA CCR SR. The passage of the vehicle through each road direction diagram is registered by the GPS and it will be shown on the screen the number associated to this diagram in the road book. According article 14.2.1 of 2023 FIA CCR SR, competitors must pass through all road direction diagrams in chronological order and cannot drive back to get a previously missed diagram. At the end of each Stage, the GPS may be inspected to control the validation of the road book diagrams. In the event of an infringement, the penalties are set out in art. 43 - Appendix I "List of Penalties" of 2023FIA CCRSR

Art. 12. Identification of officials

Competitors Relation Officer	"CRO" Pink tabard
Scrutineers	"ATB" Blue tabard or shirt
Post Chiefs:	"VEZETŐBÍRÓ" Red tabard
Special Stage Commanders:	"VEZETŐBÍRÓ" Red tabard
Marshals:	"SAFETY" / "SPORTBÍRÓ" Yellow or White or Orange tabard
Timekeepers:	"CHRONOMOTO" Black shirt

Art. 13. Penalties / Classification

Art. 13.1 Stage / Section Penalties

The penalties applied according to V2, Art. 48 and Appendix I to the FIA CCRSR will be:

TIMES ON SELECTIVE SECTIONS	FRIDAY			SATURDAY	
	PROLOGUE 9,5 HH:MM	SS2 114,16 HH:MM	SS3 114,16 HH:MM	SS4 125,41 HH:MM	SS5 125,41 HH:MM
Maximum time	00:30'	03:00'	03:00'	03:00'	03:00'
Finish in the Maximum time	Time taken	Time taken		Time taken	
Started, but not finished in the maximum time	00:45'	04:00'	04:00'	04:00'	04:00'
Not Starting	01:00'	06:00'	06:00'	06:00'	06:00'

* Subject to approval by the Stewards and force majeure.

** You must have taken start at that Leg.

Maximum time allowed may be modified by the Stewards upon the proposal of the clerk of the Course in case of non - predictable circumstances (climate, modifications in section distance, etc..)

This penalty is only applicable to crews, who:

- Complete at least 40% of the number of the selective sections of the race.
- Have started on every Leg.

Art. 14. Prizes

Overall classification:	1-6 cup
Classification by groups/classes	1-3 cup
Overall Team Classification	1-3 cup
Overall T4 Teams Classification	1-3 cup

Art. 15. Final checks / Protests / Appeals / Fines

Art. 15.1 Final Checks

Time and location: see programme (SR. Art. 3)

Any teams required to undergo final checks must immediately follow the instruction of the marshals in charge, even if this prevents them from proceeding to one or more time controls (TC). The complete original FIA homologation form, the FIA Passport and other necessary certifications must be available for final checks.

Art.15.2 Protest deposit

The protest deposit is: **EUR 1.000**

If a protest requires the dismantling and re-assembly of a clearly defined part of the car, any additional deposit will be specified by the Stewards upon a proposal of the Chief Scrutineer (FIA International Sporting Code Art. 13.4.3)

Art. 15.3 Appeal deposit

The appeal deposit for an international appeal is published on the FIA website:

<https://www.fia.com/international-court-appeal>

All protests and/or appeals must be lodged in accordance with Articles 13 and 15 of the FIA International Sporting Code and, where applicable, with and Chapter 4 of the FIA Judicial and Disciplinary Rules.

Art. 15.4 Fines

In accordance with Article 12.8 FIA International Sporting Code, the payment of the fines must be done online, within 48 hours of their notification, at the following address: <https://fiafines.fia.com>.

Any delay in making payment may entail Suspension during the period a fine remains unpaid.

Appendix 1 – Itinerary



XX. HUNGARIAN BAJA

CAR

Stage 1								2023.08.11. FRIDAY / PÉNTEK	
Sunrise		5:29						20:17 Sunset	
IE/TC	Location	SS Maximum Time	SS Km	Liasion Km	Total Km	Target Time	1st vehicle Due		
TC0A	VÁRPALOTA Parc Ferme OUT						8:00		
TC0B	Várpalota			3,33	3,33	0:10	8:10		
DSS P	PROLOGUE START					0:05	8:15		
ASS P	PROLOGUE FINISH	0:30	9,47		12,80	(0:08)	(8:23)		
	Várpalota						(Expected time of arrival)		
TC0C	Service IN (FIA Tire marking & Technical Zone)			6,73	19,53	0:10	8:33		
SERVICE A									
TC0D	Service OUT (FIA Tire marking)			0,83	20,36	0:30	9:03		
Refueling, Petrol Station,									
TC0E	Regrouping IN			0,51	20,87	0:20	9:23		
REGROUPING / START POSITION CHOOSING for LEG1 Section 2 - ONLY for the TOP 10 on Podium (Sportity)							11:00		
TC0F	Regrouping OUT						12:00		
TC1	Várpalota			2,76	23,63	0:10	12:10		
DSS 1A	START					0:05	12:15		
ASS 1A	FINISH	1:30	52,67		76,30	(0:42)	(12:57)		
	Gyulafrátót						(Expected time of arrival)		
Neutralization zone									
	Gyulafrátót			1,38	77,68	0:15	13:12		
DSS 1B	START						13:12		
ASS 1B	FINISH	1:30	57,99		135,67	(0:46)	(13:58)		
	Újmajor						(Expected time of arrival)		
Refueling, Petrol Station,									
TC1A	Service IN (FIA Tire marking & Technical Zone)			31,50	167,17	0:50	14:48		
SERVICE / SZERVIZ B									
TC1B	Service OUT (FIA Tire marking)			0,83	168,00	0:40	15:28		
TC1C	Regrouping IN			0,51	168,51	0:05	15:33		
REGROUPING									
TC1D	Regrouping OUT						16:00		
TC2	Várpalota			2,76	171,27	0:10	16:10		
DSS 2A	START					0:05	16:15		
ASS 2A	FINISH	1:30	52,67		223,94	(0:42)	(16:57)		
	Gyulafrátót						(Expected time of arrival)		
Neutralization zone									
	Gyulafrátót			1,38	225,32	0:15	17:12		
DSS 2B	START						17:12		
ASS 2B	FINISH	1:30	57,99		283,31	(0:46)	(17:58)		
	Újmajor						(Expected time of arrival)		
Refueling, Petrol Station,									
TC2A	Service IN (FIA Tire marking & Technical Zone)			31,50	314,81	0:50	18:48		
SERVICE / SZERVIZ C									
TC2B	Service OUT (FIA Tire marking)			0,83	315,64	1:20	20:08		
TC2C	Parc Ferme IN / Early Check-IN is Authorised			0,51	316,15	0:05	20:13		
Day Total			221,32	85,36	316,15				
			70,00%	27,00%	100%				



XX. HUNGARIAN BAJA

CAR

Stage 2		2023.08.12. SATURDAY / SZOMBAT					
Sunrise	5:30					20:15	Sunset
IE/TC SS	Location	SS Maximum Time	SS Km	Liasion Km	Total Km	Target Time	1st vehicle Due
TC2D	Parc Fermé OUT						10:00
Refueling, Petrol Station,							
TC3	Újmajor			29,81	29,81	0:45	10:45
DSS 3A	START					0:05	10:50
ASS 3A	FINISH	1:30	58,30		88,11	(0:47)	(11:37)
Gyulafirátót (Expected time of arrival)							
Neutralization zone							
Gyulafirátót							
				1,38	89,49	0:15	11:52
DSS 3B	START						11:52
ASS 3B	FINISH	1:40	64,50		153,99	(0:51)	(12:43)
Várpalota (Expected time of arrival)							
TC3A	Service IN (FIA Tire marking & Technical Zone)			3,95	157,94	0:10	12:53
SERVICE / SZERVIZ D							
TC3B	Service OUT (FIA Tire marking)			0,83	158,77	0:40	13:33
Refueling, Petrol Station,							
TC3C	Regrouping IN			0,51	159,28	0:20	13:53
REGROUPING							
TC3D	Regrouping OUT						14:15
TC4	Újmajor			29,81	189,09	0:45	15:00
DSS 4A	START					0:05	15:05
ASS 4A	FINISH	1:30	58,30		247,39	(0:47)	(15:52)
Gyulafirátót (Expected time of arrival)							
Neutralization zone							
Gyulafirátót							
				1,38	248,77	0:15	16:07
DSS 4B	START						16:07
ASS 4B	FINISH	1:40	64,50		313,27	(0:51)	(16:58)
Várpalota (Expected time of arrival)							
TC4A	Parc Ferme IN / Early Check-IN is Authorised			3,95	317,22	0:15	17:13
Day Total		245,60	71,62	317,22			
		77,42%	22,58%	100%			

Section 4

Section 5

	SS km	Liasion km	Total km
Rally Total	466,92	156,98	633,37
	73,72%	24,78%	100%

Appendix 2 Names and photographs of the Competitors Relation officer(s) and their schedules



Mr. István Mátrai Jr.
(ENG / DEU / HUN)
+36 20 417 6249

Estimated working plan:

Thursday 10. August	Admin check Scrutineering Briefing / Start TC / Start Ceremony	08:00 – 15:00 09:00 – 18:00 19:00 – 21:00
Friday 11. August	Parc Fermé / Service area	08:30 – 22:30
Saturday 12. August	Parc Fermé / Service area Finish Ceremony	08:30 – 18:00 19:00

Appendix 3 – Decals and positioning of supplementary advertising

List and positioning of advertising

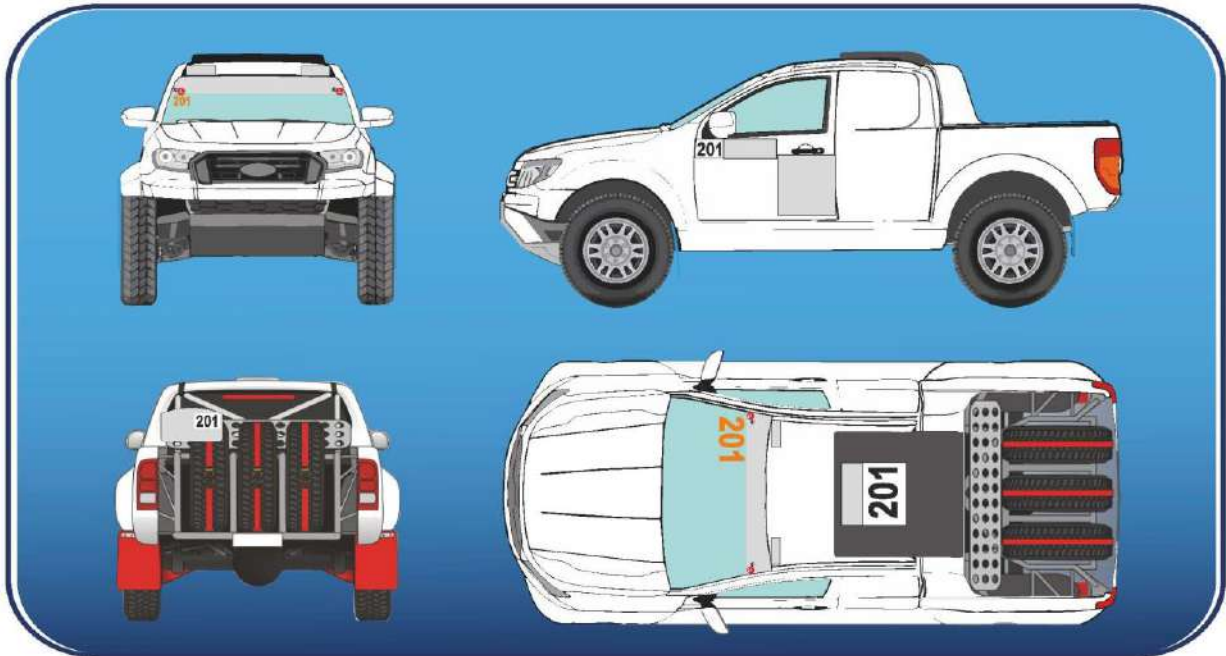
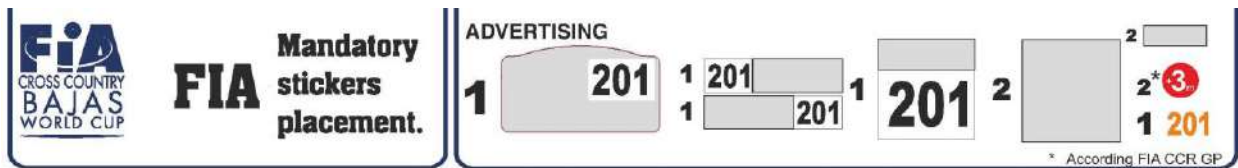

Matricák felhelyezése / Positioning of the stickers:

1. Rajtszám / Competition nr.: 67x22cm
2. Reklámtábla / Advertizing decal : 30x30cm
3. Szélvédő matrica / Windshield advertising sticker: 25x10 cm
4. +3 perc / +3 minute
5. Szélvédő Rajtszám / Windshield start number: 20x10 cm
6. Tetőrajtszám / Roof start number: 50x50cm
7. Rallytábla / Rallyplate: 21x10cm



Appendix 4 – Extracts from FIA ISC Appendix L relating to overalls, helmets and any other safety requirements.

All competitors are reminded of Appendix L of the FIA International Sporting Code, in particular its Chapter III - Drivers' Equipment.

Helmets (Appendix L, Chapter III, Art. 1)

All crews must wear crash helmets homologated to one of the FIA standards listed in Appendix L.

Frontal Head Restraint (FHR, Appendix L, Chapter III, Art. 3)

All crews must use FIA approved FHR systems homologated to FIA standard 8858.

Approved FHRs, anchorages and tethers are listed in Technical List N° 29.

See also helmet compatibility chart in Appendix L, Chapter III, Art. 3.3.

Flame-resistant clothing (Appendix L, Chapter III, Art. 2)

All drivers and co-drivers must wear overalls as well as gloves (optional for co-drivers), long underwear, a balaclava, socks and shoes homologated to the FIA 8856-2000 standard, technical List N°27, or 8856-2018, technical List N° 74 (Mandatory for all FIA priority drivers and their co-driver). Please pay special attention to the prescriptions of Art. 2 concerning embroidery and printing on flame-resistant clothing (manufacturer certificates etc.) as well as concerning the correct wearing of the clothing elements! See also FIA Cross-Country Rally Sporting Regulations Article 47.1.

Biometric Devices (Appendix L, Chapter III, Art. 2.1)

Drivers may wear a device to collect biometric data during racing.

- If the biometric device is integrated into a protective garment homologated to FIA Standard 8856, the garment shall be homologated to FIA Standards 8856 and 8868-2018.
- If the biometric device is a stand-alone device, then the device must be homologated to FIA Standard 8868-2018 only. This device must be worn in addition to the garment homologated to FIA Standard 8856.

Wearing of jewellery (Appendix L, Chapter III, Art. 5)

The wearing of jewellery in the form of body piercing or metal neck chains is prohibited during the competition and may therefore be checked before the start.

MEDICAL AND SURVIVAL KIT (Appendix IV of the Cross-Country Rally Sporting Regulations)

A sealed and valid Medical kit in accordance with the Specification for Cross Country Rallies and Bajas (Technical List n°83) must be placed inside the cockpit. The minimum weight must comply with Technical List n°83.

RELATED LINKS:

FIA International Sporting Code and appendices:

<https://www.fia.com/regulation/category/123>

FIA Technical Lists:

<https://www.fia.com/regulation/category/761>



MAIN SCREEN

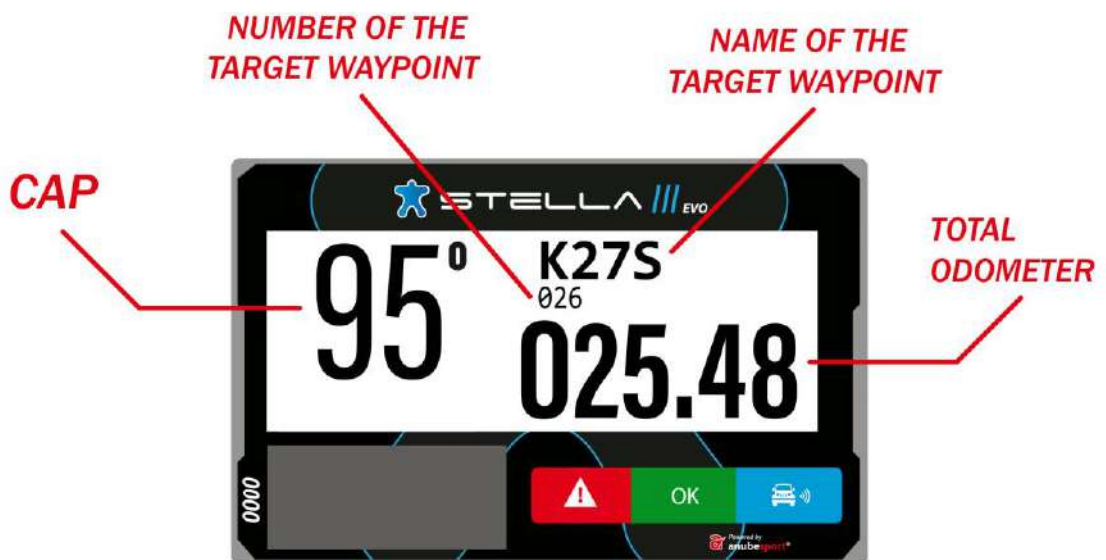

WAYPOINT PROXIMITY



SPEED ZONE

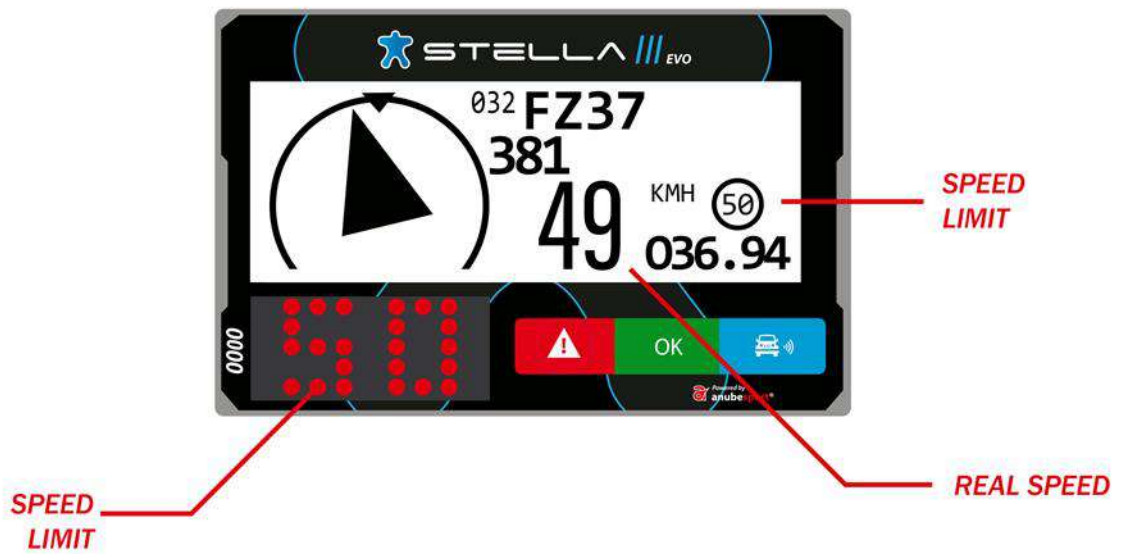

REQUEST MEDICAL ATTENTION IMMEDIATELY



SOS

1 sec.



CAUTION VEHICLE STATIONARY



3 sec.
BREAKDOWN



DANGER 3 !!!



Notification 300m before an area marked in the roadbook as "Danger 3"

OVERTAKING / BLUE FLAG



OVERTAKING / BLUE FLAG



STEADY



FLASHING



OVERTAKING / BLUE FLAG



FREE TO OVERTAKE



STEADY

PRESS THE BLUE BUTTON TO CONFIRM

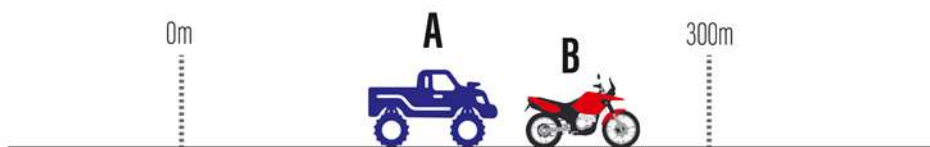

SPEED LIMIT



SPEED LIMIT

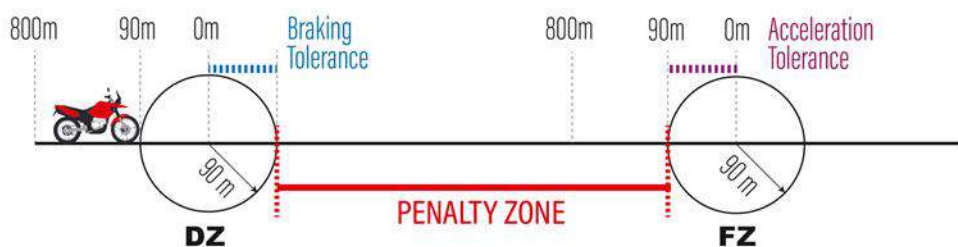

SPEED LIMIT



RED STEADY Inside of speed zone
RED FLASHING Overspeed

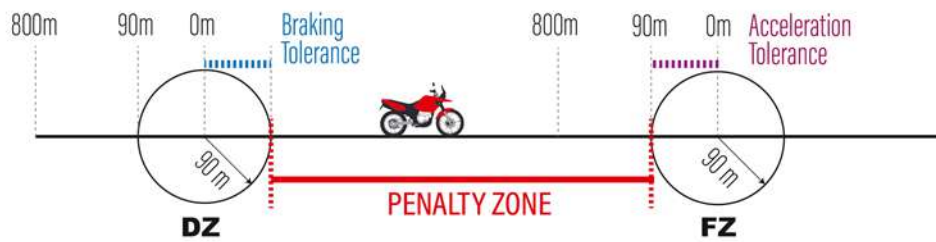

SPEED LIMIT



OFF end of speed zone

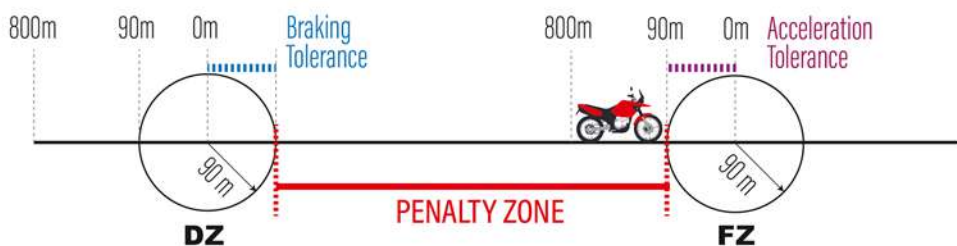

NEUTRALIZATION ZONE

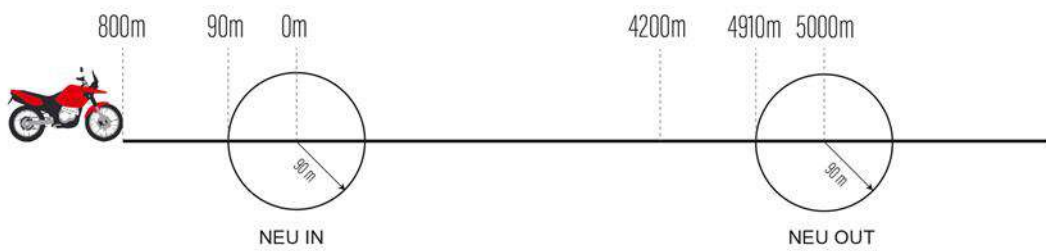

NEUTRALIZATION ZONE

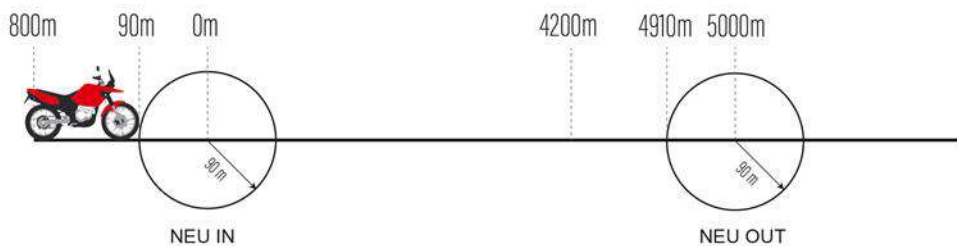

NEUTRALIZATION ZONE

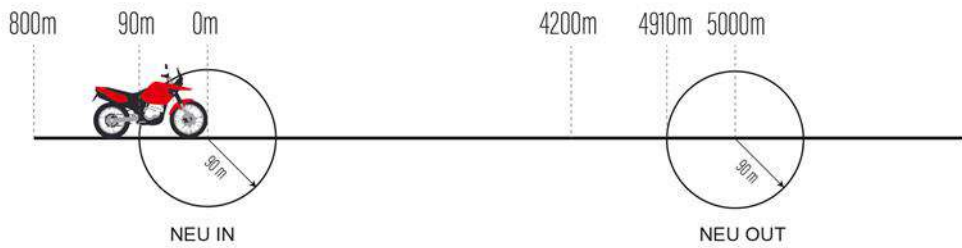

NEUTRALIZATION ZONE

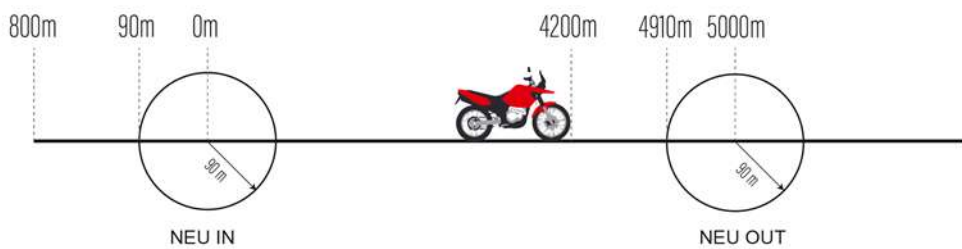

NEUTRALIZATION ZONE

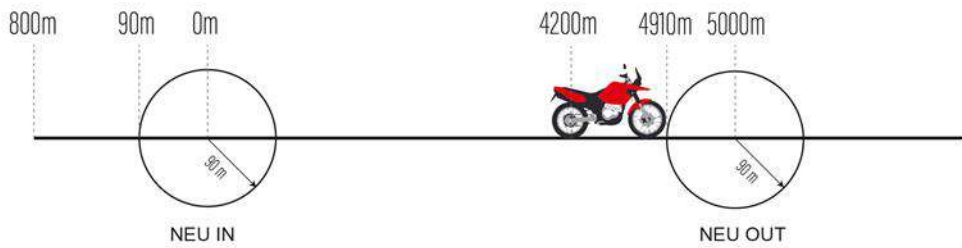
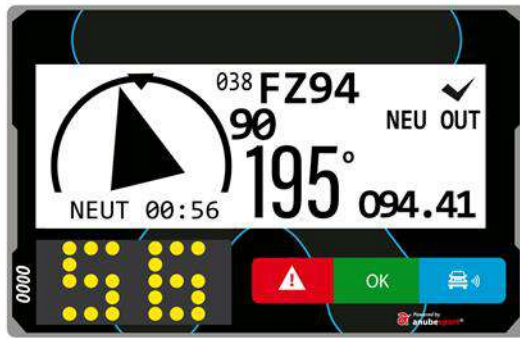

NEUTRALIZATION ZONE

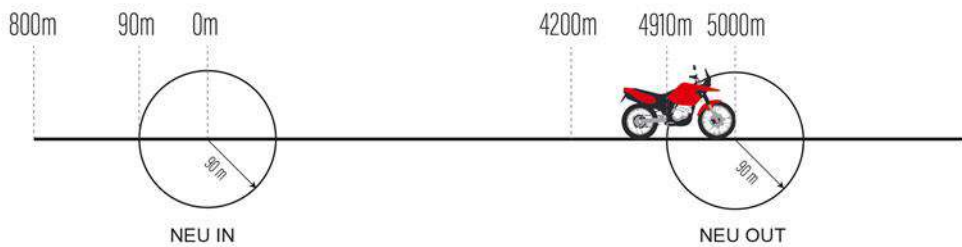

MESSAGES

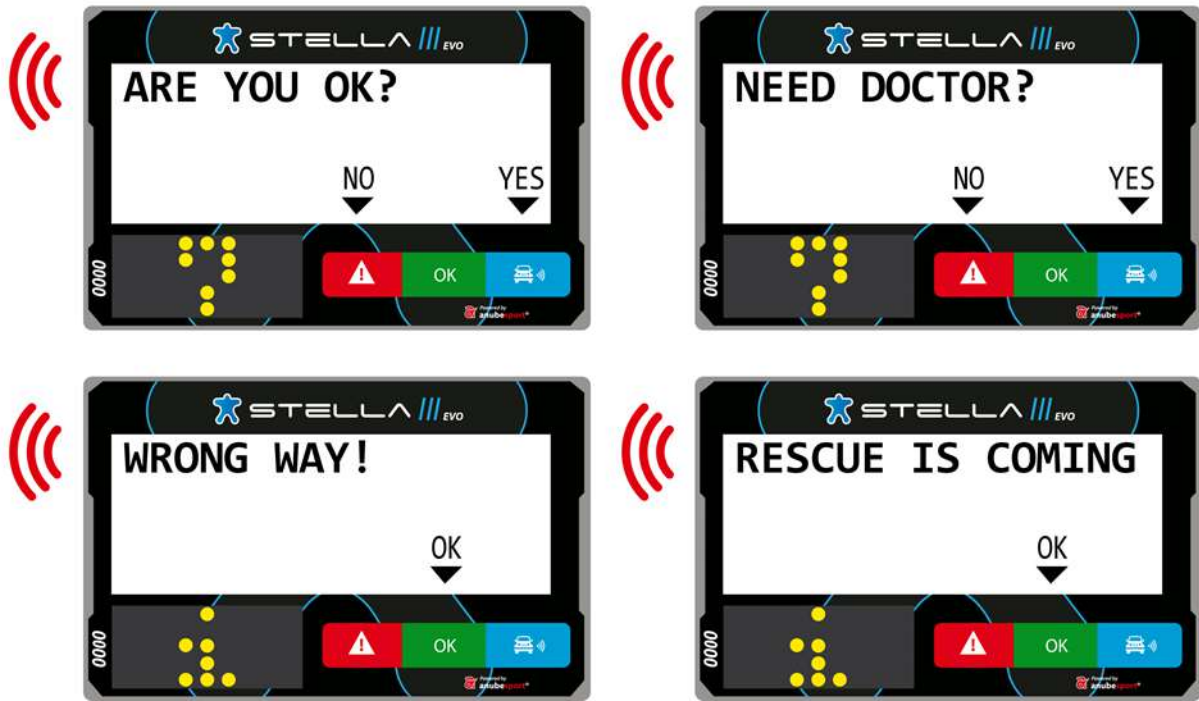

WAYPOINTS LIST

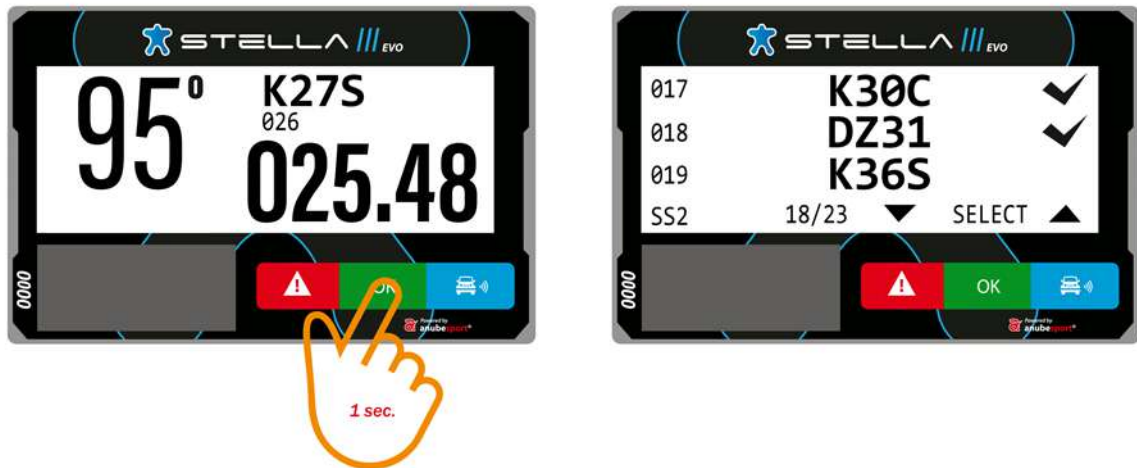

TOTAL ODOMETER RESET TO ZERO



OK

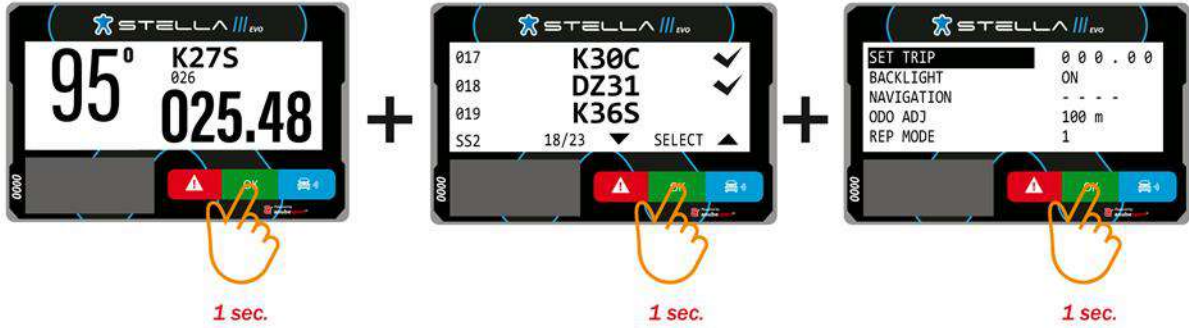

Appendix 6 Kit components and Instructions for the use of the car-to-car communication system

KIT COMPONENTS 80€

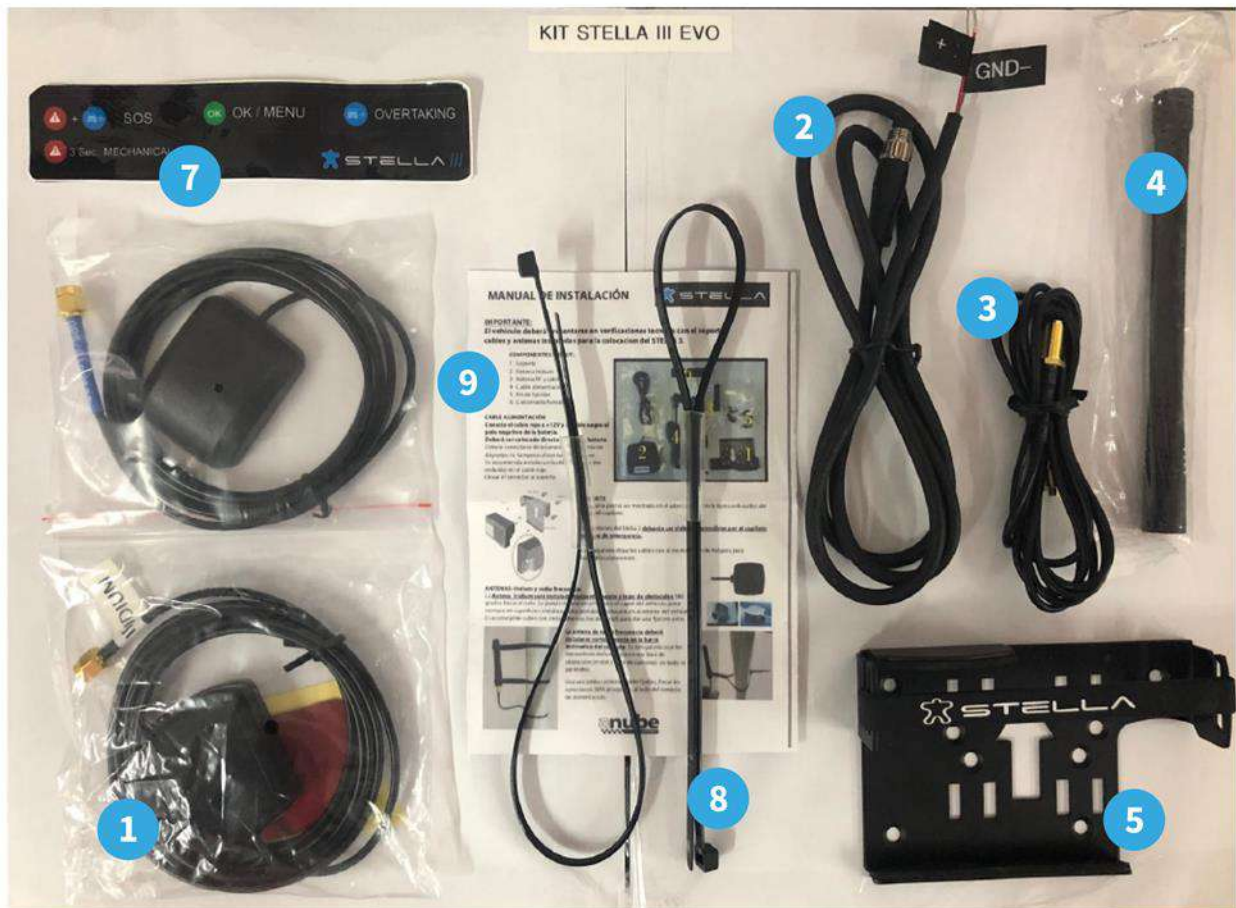

1. Iridium Antenna
2. Power Cord
3. RF Cord
4. RF Antenna
5. Base/Mount
6. GPS Antenna
7. Adhesive
8. Straps
9. User Manual

IMPORTANT

For the functional tests and verification, all vehicles must have gone through the installation of the mount, power cord, and antennas.

The radio-frequency antenna must be installed vertically to the roll cage bars (cars and SSV) and the forks (ATV). It is mandatory to use separators (included in the kit) to avoid contact with metallic parts and the carbon fibre that surrounds it. Once the antennas are mounted, take the SMA connection cords to the base/mount where the STELLA III EVO will be installed.

1. POWER CORD

- Connect the red wire to the positive end of the battery 12V(+), and the grey wire to the negative end (GRD). The power cord must be connected directly to the battery (without interruptions and without contact in the power supply).
- A 3A fuse (not included) should be connected to the red wire.
- Take the cord to the location in which the STELLA III EVO is to be installed. All other wires must be insulated, they cannot touch.

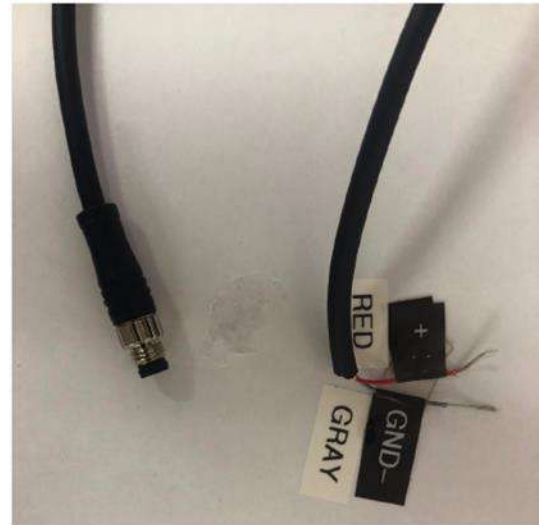

2. BASE/MOUNT

- Motorcycles and ATV: The mount can be attached to the handle bar or to a metal plaque close to the navigation system.
- Cars and UTV: The mount can be attached to the panel, or to the roll cage bars. STELLA III EVO buttons must be visible and accessible to the participant (pilot/navigator) even when they are sitting and with the seatbelts buckled.

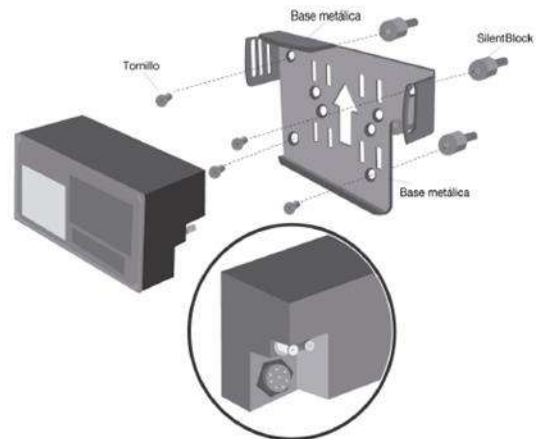

IMPORTANT

Leave the cords (antenna and battery) in place with at least 10 cm to spare for easy handling.
At least 5 cm of space behind the mount (bottom right corner) to allow space for power cord/connections.

3. GPS ANTENNA

The GPS antenna must be installed horizontally and without obstructions toward the sky. In cars and UTV, it can be mounted on the roof, the hood, or the dashboard. In motorcycles and ATV, attach to the mudguard. For additional firmness, it is recommended to cover it with adhesive tape (non metallic when mounting it to a metallic surface) and pull-up (when attached to soft or plastic parts).



4. ANTENNA IRIDIUM

The Iridium antenna must be installed horizontally and without obstructions toward the sky. In cars and UTV, it can be mounted on the roof, the hood, or the dashboard. In motorcycles and ATV, attach to the mudguard. For additional firmness, it is recommended to cover it with adhesive tape (non metallic when mounting it to a metallic surface) and pull-up (when attached to soft or plastic parts).



5. RF ANTENNA

The radio-frequency antenna must be installed vertically to the roll cage bars (cars and UTV) and the forks (motorcycles and ATV). It is mandatory to use separators (included in the kit) to avoid contact with metallic parts and the carbon fibre that surrounds it.

Once the antennas are mounted, take the SMA connection cords to the base/mount where the STELLA III EVO will be installed.



Appendix 7 Items at the organisers' discretion

After the Prize Giving Ceremony, we are delighted to announce that a jubilee party will be held in celebration of the XX-th Hungarian Baja, and we warmly invite everyone to join us. We kindly recommend making accommodation arrangements accordingly.

We wish everyone a safe and accident-free competition!