



10-02. August 2023

MAMS CROSS-COUNTRY RALLY CUP

SUPPLEMENTARY REGULATION

CONTENTS:

INTRODUCTION	3
PROGRAMME	3
1.DESCRPTION	4
2.ORGANIZER	6
3.ENTRIES	7
4.INSURANCE	8
5.ADVERTISING	8
6.IDENTIFICATIONS	8
7.TYRES	8
8.FUEL	8
9.ADMINISTRATIVE CHECKS	8
10.TECHNICAL SCRUTINEERING, SEALING AND MARKING	9
11.QUALIFYING STAGE	9
12.START OF THE EVENT	9
13.RUNNING OF THE EVENT	10
14.SERVICEPARK	11
15.PROTEST AND APPEALS	11
16.FINAL CHECKS	11
17.RESULTS	11
18.PRIZES	11

Appendix 1_Timetable

Appendix 2_Relations crew officer

Appendix 3_ Instruction for the use of the GPS Tracking System

Appendix 4_GPS Installation Kit

Appendix 5_ Items at Organizer's discretion

XX.HUNGARIAN BAJA is organised by **Garilla Racing Kft.** and **Garzone s.r.o** on 10-12. 08. 2023.

The race has the following regulations, which will apply to all drivers and competitors signing the entry form:

- MAMS International Open Baja Cup regulations
- Traffic Regulations Hungary
- The present Supplementary Regulations and its appendices,
- Official bulletins

MAIN LOCATIONS		
REGISTRATION	TESCO parking lot 8100 Várpalota, Fehérvári str. 17.	N47°12'00 E18°09'08
SERVICE PARC M/Q	GÁL GYULA SPORS HALL parking lot 8100. Várpalota, Fehérvári str. 9.	N 47°11'59.4132" E 18°8'48.7926"
RALLY OFFICE HQ	THURY CASTLE 8100. Várpalota, Hunyadi Mátyás Square 1.	N47°12'05 E18°08'20
SCRUTINEERING	TESCO 8100. Várpalota, Fehérvári str. 17.	N47°12'00 E18°09'08
PARC FERMÉ	VÁRPALOTA FŐTÉR 8100. Várpalota, Szabadság Square	N47°11'58 E18°08'26

LENGHT OF SELECTIVE SECTIONS

Stage 1: 221,32 km

Stage 2: 245,60 km

TOTAL 466,92 km

Overall SS distance and total distance of the itinerary

Number of Stages 2
 Number of Sections 5
 Number of Selective Sections 5
 Total distance of the itinerary 633,37 km

Route terrain on Selective Sections:

Gravel/dirt tracks 100 %

PROGRAMME			
Date:	Time:		Location:
14.06.2023	10:00	Publishing of the supplementary regulations	www.hungarianbaja.com
01.06.2023	10:00	Entries open	
07.06.2023	16:00	Issuing of Rally Guide	
10.07.2023	24:00	Closure date of entries at reduced fees	www.hungarianbaja.com
01.08.2023	24:00	Closure date of entries	www.hungarianbaja.com
01.08.2023	24:00	Closing date for order of extra service in SP	info@hungarianbaja.com
01.08.2023	24:00	Closing date for shakedown registration	

02.08.2023	16:00	Publication date of entry list	Sportity, www.hungarianbaja.com
02.08.2023	10:00	Press conference before the rally	Thury Castle, Várpalota
09.08.2023	16:00-20:00	Registration, Check List and Service Plate delivery	TESCO, Várpalota
10.08.2023	07:00-18:00	Registration, Check List and Service Plate delivery	TESCO, Várpalota
10.08.2023	08:00-15:00	Administrative checks	Thury Castle, Várpalota
10.08.2023	08:00	Collection of material and documents	Thury Castle, Várpalota
10.08.2023	08:00	Collection of rally safety tracking system	Thury Castle, Várpalota
10.08.2023	08:00	Collection of navigation GPS (NAV-GPS)	Thury Castle, Várpalota
10.08.2023	08:00-16:00	Scrutineering – sealing & marking of components	TESCO, Várpalota
10.08.2023	08:00	Opening of media centre	Thury Castle, Várpalota
10.08.2023	11:00-14:00	Shakedown	Várpalota, according to SD Roadbook
10.08.2023	15:00-18:30	Parc-Fermé	Várpalota, Szabadság Square
10.08.2023	19:00	Team managers and/or Drivers' briefing Issuing of the road book (Stage 1)	Thury Castle, Várpalota
10.08.2023	20:00	Publication of start list for Ceremonial Start	DNB
10.08.2023	20:00	Publication of list of vehicles eligible to start	DNB
10.08.2023	20:00	Publication of start list for Stage 1	DNB
10.08.2023	21:00	Ceremonial Start	Thury Castle, Várpalota
11.08.2023	09:30	Start of the Rally – Stage 1, Section 1 (TC0) Prologue	Thury Castle, Várpalota
11.08.2023	10:33	Finish of Section 1 (estimated time of 1 st vehicle)	Thury Castle, Várpalota
11.08.2023	10:40	Start of Stage 1, Section 2 (estimated time of 1 st vehicle)	Thury Castle, Várpalota
11.08.2023	18:43	Finish of Stage 1 (estimated time of 1 st vehicle)	Thury Castle, Várpalota
11.08.2023	20:00	Publication of start list for Stage 2	DNB
12.08.2023	08:00	Start Stage 2 (estimated time of 1 st vehicle)	Thury Castle, Várpalota
12.08.2023	15:13	Finish of Stage 2 (estimated time of 1 st vehicle)	Thury Castle, Várpalota
12.08.2023	15:30	Final scrutineering; Immediate after arrival in the finish (following the marshals' instructions)	MÁRIA GUMI, Várpalota
12.08.2023	17:00	Publication of Provisional Classification	DNB
12.08.2023	17:30	Publication of Final Classification; After the Jury have declared the Classification final.	DNB
12.08.2023	18:00	Podiums Ceremony / Prize-giving	Thury Castle, Várpalota

1. DESCRIPCION

1.1 PLACE AND DATE OF THE EVENT:

XX.HUNGARIAN BAJA is taking place in Várpalota surroundings, county Veszprém, Hungary, on 10-12 August, 2023.

1.2 TITLES FOR WHICH THE HunGarian Baja COUNTS:

FIM Bajas World Cup and International Open Baja Cup (2023)

MAMS International Open Baja Cup, with International Participants

1.3 VISA NR:

MAMS: MAMS/049/2023

EMN: 34/325

IMN Nr: 814/05

1.4 LOCATION OF BAJA OFFICE:

From 14.06.2023 GARILLA RACING KFT.
H- 8200 Veszprém, Házgyári str. 1.
Tel: +36-30-791-4270
e-mail: info@hungarianbaja.com
web: www.hungarianbaja.com

From 10.08.2023 Thury Castle, Hunyadi Mátyás Tér 1., 8100 Várpalota
GPS COORDINATE: N47°12'05 E18°08'20

1.5 START/ FINISH:

LOCATION: FŐTÉR, Szabadság Tér, 8100 Várpalota

1.6 PRESS OFFICE LOCATION:

LOCATION: THURY CASTLE, Hunyadi Mátyás Tér 1., 8100 Várpalota

TIME: Friday 11. August 2023 08:00-21:00 hrs
Saturday 12. August 2023 08:00-20:00 hrs

1.7 OFFICIAL NOTICE BORD:

Digital Notice Board (DNB): [Sportity](https://www.sportity.com), www.chromomoto.hu, www.hungarianbaja.com



On PC: https://webapp.sportity.com/channel/HGB23_MAMS

1.8 SCRUTINEERING (at the scheduled time):

TESCO Parking, 8100. Várpalota, Fehérvári str. 17. GPS Koordináta: N47°11'58, E18°19'13

1.9 LOCATION PARC FERMÉ:

Várpalota Főtér GPS COORDINATE: N47°11'58, E18°08'26
Szabadság Tér, 8100 Várpalota

1.10 LOCATION SERVICE PARK:

GÁL GYULA SPORS HALL parking lot

8100. Várpalota, Fehérvári str. 9. GPS COORDINATE: N 47°11'59.4132" E 18°8'48.7926"

2. ORGANIZER

2.1 ORGANIZER'S NAME:

Garilla Racing Kft. and Garzone s.r.o.

2.2 ORGANIZER'S ADDRESS AND CONTACT DETAILS:

Garilla Racing Kft.

Responsible for competition: Garamvölgyi Zoltán

info@garzoneracing.com

Phone: +36 30/791-4270

GarZone s.r.o. Vel'koblahovská 75/39, Dunajská Streda, Slovakia

info@garzoneracing.com

2.3 ORGANIZING COMMITTEE:

President of the Organizing Committee:

Mr. Zoltán GARAMVÖLGYI

Members of the Organizing Committee:

Mr. Sándor NÉMETH

Mr. Ferenc SCHEIBENHOFFER

2.4 OFFICIALS:

Clerk of the course

Mr. János FALICS

Deputy of Clerk of the Course:

Mr. Richárd KELEMEN

Jury Prezident

Mrs. Brigitta VARGA

Chief Scrutineer

Mr. Gábor FARKAS

Medical Officer:

Dr. Zoltán PÁLL

Safety Officer:

Mr. Sándor NÉMETH – Kékfény Security

Head of Secretary:

Ms. Julianna TÖRÖK

Secretary to the Jury

Mrs. Éva HORVÁTH

Competitors Relation's Officer:

Mr. István MÁTRAI

Mrs. Mariann MAGYAR KELEMENNÉ

Press Officer:

Mr. Anita TÓTH

Timekeeping Results:

ChronoMoto Kft.

GPS Control Results:

STELLA

Environmental Officer :

Mr. Péter BAKÓ

Responsible for Road Book:

Mr. László POLGÁR

Responsible for checking the Road Book:

Mr. Péter FALUVÉGI

2.6 IDENTIFICATION OF OFFICIALS:

Competitors Relation Officer

“CRO” Pink tabard

Scrutineers

“ATB” Blue tabard or shirt

Post Chiefs:

“VEZETŐBÍRÓ” Red tabard

Special Stage Commanders:

“VEZETŐBÍRÓ” Red tabard

Marshals:

“SAFETY” / “SPORTBÍRÓ” Yellow or White tabard

Timekeepers:

“CHRONOMOTO” Black shirt

3. ENTRIES

3.1 DATES:

OPENING date for ENTRIES: 01. 06. 2023. 10:00 hrs

CLOSING date for ENTRIES: 01. 08. 2023. 20:00 hrs

3.2 ENTRY PROCEDURE:

You can submit your entry on the following website: www.hungarianbaja.com. Signed Entry Forms, together with the proof of transfer payment, and scan copies or pictures of all documents related to Administrative Checks should be sent to the following email address: julianna@garzonercing.com.

3.3 NUMBER OF ENTRIES AND GROUPS:

The number of competitors must be a minimum of 15 vehicles.

Groups: Motor, Quad

3.4 ENTRY FEE, OTHER:

3.4.1. ENTRY FEE

EUR 450 **payment transferred** up to closing date of entry: **01.08.2023**

The entry fee includes:

- Additional compulsory liability insurance
- Basic service plate/competing vehicle (1pc)
- Basic service area per vehicle (30m²)
- GPS navigation and safety tracking system STELLA Rental Fee (175 €)

Team Registration: 100€

3.4.2. TO BE PAYED ON SITE!

Deposit for GPS navigation and safety tracking system: 100 €

GPS navigation and safety tracking system's **installation kit**: 80 €

For a Service area up to 30m², max 2 entry permission can be purchased! Teams, who want to enter with more vehicles, must purchase an additional 30m² service area. Service areas requested and the number of service vehicles has to be indicated on the Entry Form.

3.4.3. OTHER FEES

- additional permission to the service parc (service plate): 30 €
- Additional service area (30m²): 30 €
- Trailers, Motorhomes, Promotion Vehicles: 60 €

3.5 PAYMENT METHOD:

Any entry not accompanied by the entry fee shall be null and void.

The entry fee should be transferred to the following bank account(€):

GARZONE s.r.o.: Dunajská Streda, Vel Koblachovská str. 75/39, Slovakia, Slovenská Sporiteľna, a.s.

Account Nr: 5063476359/0900

IBAN N°: SK2609000000005063476359

SWIFT: GIBASKBX

please note: „ENTRY FEE Hungarian Baja 2023 and Competitors name”

The Application form will be accepted only with the proof of payment of the fee.

Signing the Entry Form, competitors agree that the GPS system operators give their data to the organizer, the event’s officials.

4. INSURANCE

Complementary compulsory liability insurance Included in Entry Fee!

5. ADVERTISING

The logos will be published in Bulletin

- 1 - Three race number panels with compulsory advertising 20 x 20 cm on each side and on the front of the vehicle
- 2 - One rally plate placed vertically at the front of the vehicle
- 3 - One race number panel with compulsory advertising 30 x 30 cm to the back of the Riders jacket

Compulsory or optional advertising absent or incorrect affixing will entail a penalty of 50% of the entry fees. In case of repeated offence, it will go up to exclusion.

6. IDENTIFICATION

Considering MAMS General Prescription Art.nr.15.

7. TYRES

Considering MAMS General Prescription Art.nr.11.

8. FUEL

Only commercially available fuel can be used, without adding any additives, marked in the Road Book.

On SS1A, SS1B, SS2A, SS2B, SS3A, SS3B, SS4A, SS4B will be a Neutralization Zone for all Competitors and a separate Remote Refuelling Zone (RRZ) for Motor, Quad, SBS(Nat) vehicles only.

9. ADMINISTRATIVE CHECK

Before Administrative Check, each vehicle must **Register** at the Registration tent, TESCO Parking lot, Várpalota, Fehérvári str.17., where the Checklist and Service Plates will be provided.

9.1 LOCATION: THURY CASTLE, Hunyadi Mátyás Tér 1.
GPS COORDINATE: N 47° 5'7” E 17°58'10”

9.2 TIMES SCHEDULE: 10.08.2023 08:00-15:00

Individual times for each competitor for the administrative checks will be published on Sportity and www.hungarianbaja.com in a Bulletin.

GPS tracking system rental is compulsory before the administrative check.

9.3 DOCUMENTS TO BE PRESENTED:

To minimize the time required for administrative check, please make a photo or scan copies of the documents required, and send them to the following email address: julianna@hungarianbaja.com.

Make sure to bring and present the original of the documents as well:

- Competitor’s licence
- Driving licence
- Vehicle’s registration document

- Vehicle's compulsory insurance policy
- Starting Permission (who is concerned)
- Authorization (if needed)

10. TECHNICAL SCRUTINEERING, SEALING AND MARKING

10.1 LOCATION: Tesco, 8100 Várpalota, Fehérvári Str.17

10.2 TIME: 10.08.2023. 08:00-16:00

Individual times for each competitor for the administrative and technical checks will be published on Sportity and www.hungarianbaja.com in a Bulletin

Competitors has to present for technical scrutineering with their helmets!

10.3 REQUIREMENTS AT TECHNICAL SCRUTINEERING:

- Vehicles must be presented with all start numbers, rally plates, and advertisements fixed properly on the designated place.
- Tracking equipment and inter-vehicle signalling system installed and operable even when the ignition removed, it is compulsory to provide 12V
- Scrutineering Sheet- filled up

10.4 PARC FERMÉ:

Following the technical scrutineering, each vehicle must be set in Parc Fermé 15:00-18:30

Location: FŐTÉR, Szabadság Tér

10.5 SAFETY REQUIREMENTS:

All competitors are obliged to use a GPS Navigation and Safety Tracking System (STELLA), to buy the installation kit if is necessary before the Administrative Check. Returning the GPS and collecting the deposit: at the Parc Fermé to the STELLA crew.

The instruction for the use of the Tracking System is in the Appendix 3. of these Supplementary Regulation.

11. PROLOGUE

TIME: 11.08.2023. 09:30

12. START OF THE EVENT

12.1 PARC FERME BEFORE THE OFFICIAL START:

LOCATION: FŐTÉR, Szabadság Tér

DATE: 10.08.2023. 15:00-18:30

12.2 BRIEFING (COMPULSORY)

LOCATION: THURY CASTLE, Hunyadi Mátyás Tér 1.

DATE: 10.08.2023. 19:00

12.3 ROAD BOOK PROVIDING

- At Briefing: Road Book for Stage1: 19:00
- Entering Park Fermé at the end of Stage1: Road Book for Stage2

12.4 PUBLICATION OF START LIST AND STARTING POSITION:

On Digital Notice Board, according to the programme above: [Sportity](#), www.chronomoto.hu, www.hungarianbaja.com

12.5 OFFICIAL START:

According to the programme above.

13. RUNNING OF THE EVENT

13.2 TIME CARD PROVIDING/EXCHANGES

Time cards will be issued before the Start of each Leg, which must be submitted to the marshalls at the Finish of each Leg. The time card must be filled up by the competitor as instructed by the marshalls.

Time card exchanging: at regrouping.

13.3 LIMITED TIME DELAY

Maximum delay between two TC is 30 minutes per Leg. Delay exceeding this limit will result in disqualification.

13.4 FIXED PENALTY

Competitors who got fixed penalties on the day of the race, can revert to the race- at regrouping areas and parc –fermé at the end of the day, until the first vehicle's planned time, in compliance with the other rules described in the TROB Regulations. The Timecard and Time schedule contains the maximal times at the selective stages.

13.5 EARLY CHECK IN AT THE END OF LEG:

Early-check in is allowed at TC2C and TC4A

13.6 PARC FERMÉ:

Before the Start and between Legs, all vehicles must be placed to the Parc Fermé (for the night).

LOCATION: FŐTÉR, Szabadság Tér

13.7 FAULT START:

Vehicles, that cannot take the Start- in accordance with the TROB General Prescriptions point 41.1 can be pushed out from the timecontrol zone.

13.8 AVAILABILITY OF PARTICIPANTS

Participants who park their vehicles in the Parc Fermé upon passing the finish line, must remain available by phone (mobile) until the final classification have been posted.

13.9 ELECTRONIC START PROCEDURE AT THE START OF A SELECTIVE SECTION

The start of the selective section is happening based on an electric clock and lamp, connected to a false start alert system.

When the m/q arrives at the start line, the front of the m/q should be positioned behind a stick placed by the marshal to define the exact start position. One minute before the start time, but not before the car has stopped in its exact position, the marshal shall remove the stick and the competitor shall refer to the automatic countdown clock. Any subsequent change of the m/q's position until its start time is not permitted and will be reported to the Jury.

13.10 RECOGNASSANCE

Recoinnassance of the entire Hungarian Baja route is forbidden.

14. SERVICEPARK

14.1 LOCATION:

GÁL GYULA SPORS HALL parking lot (with shower and toilet facility in the Sports Hall)

N 47°11'59.4132" E 18°8'48.7926"

8100. Várpalota, Fehérvári str. 9.

14.2 OTHER:

Entry will be permitted in the Service Park only showing the Service Plates provided by the Organizer. Accompanying team cars can enter only by purchasing a 10.000HUF sticker at the Administrative Checks.

Using a min 2x1m protector groundsheet under the racing vehicles is mandatory. 1pc at least 4kg validated manual fire extinguisher is mandatory. Each service team has to ensure that after carrying out their activities on the site, they do not leave any pollutants. They will be checked by the environmental officer, and not complying will entail a 50.000HUF fine.

The Organizer calls the attention of the participants, that the Service Park is not guarded at night time!

15. PROTEST AND APPEALS

Protest fee: MAMS Cross-Country General Prescriptions

16. FINAL CHECKING

LOCATION: MÁRIA GUMI

TIME: 12.08.2023. Immediate after arrival in the finish

17. RESULTS

17.1 PUBLICATION PROVISIONAL OVERALL CLASSIFICATION:

Digital Notice Board: Sportity, www.hungarianbaja.com and www.chronomoto.hu

17.3 PUBLICATION FINAL OFFICIAL CLASSIFICATION:

Digital Notice Board: Sportity, www.hungarianbaja.com and www.chronomoto.hu

18. PRIZES

18.1 PRIZE GIVING CEREMONY:

LOCATION: FŐTÉR, Szabadság Tér

TIME: 12.08.2023. 18:00

18.2 PRIZES:

Overall 1-3 - cup

Categories 1-3 - cup

LICENCE NR:

MAMS: MAMS/049/2023

EMN: 34/325

IMN Nr: 814/05

Appendix 1_Timetable



XX. HUNGARIAN BAJA

MOTO

Stage 1								2022.08.11. FRIDAY / PÉNTEK	
Sunrise 5:29								20:17	Sunset
IE/TC	Location	SS Maximum Time	SS Km	Liasion Km	Total Km	Target Time	1st vehicle Due		
TC0A	VÁRPALOTA Parc Ferme OUT						9:30	Section 1	
TC0B	Várpalota			3,33	3,33	0:10	9:40		
DSS P	PROLOGUE START					0:05	9:45		
ASS P	PROLOGUE FINISH	0:30	9,47		12,80	(0:08)	(9:53)		
	Várpalota					(Expected time of arrival)			
TC0C	Service IN			6,73	19,53	0:10	10:03		
SERVICE A									
TC0D	Service OUT			0,83	20,36	0:15	10:18		
Refueling, Petrol Station,									
TC0E	Regrouping IN			0,51	20,87	0:15	10:33		
REGROUPING									
TC0F	Regrouping OUT						10:40	Section 2	
TC1	Várpalota			2,76	23,63	0:10	10:50		
DSS 1A	START					0:05	10:55		
ASS 1A	FINISH	1:30	52,67		76,30	(0:42)	(11:37)		
	Gyulafirátót					(Expected time of arrival)			
Neutralization zone									
	Gyulafirátót			1,38	77,68	0:15	11:52		
DSS 1B	START						11:52		
ASS 1B	FINISH	1:30	57,99		135,67	(0:46)	(12:38)		
	Újmajor					(Expected time of arrival)			
Refueling, Petrol Station,									
TC1A	Service IN			31,50	167,17	0:50	13:28		
SERVICE / SZERVIZ B									
TC1B	Service OUT			0,83	168,00	0:30	13:58		
TC1C	Regrouping IN			0,51	168,51	0:05	14:03		
REGROUPING									
TC1D	Regrouping OUT						14:30	Section 3	
TC2	Várpalota			2,76	171,27	0:10	14:40		
DSS 2A	START					0:05	14:45		
ASS 2A	FINISH	1:30	52,67		223,94	(0:42)	(15:27)		
	Gyulafirátót					(Expected time of arrival)			
Neutralization zone									
	Gyulafirátót			1,38	225,32	0:15	15:42		
DSS 2B	START						15:42		
ASS 2B	FINISH	1:30	57,99		283,31	(0:46)	(16:28)		
	Újmajor					(Expected time of arrival)			
Refueling, Petrol Station,									
TC2A	Service IN (FIA Tire marking)			31,50	314,81	0:50	17:18		
SERVICE / SZERVIZ C									
TC2B	Service OUT			0,83	315,64	1:20	18:38		
TC2C	Parc Ferme IN / Early Check-IN is Authorised			0,51	316,15	0:05	18:43		
Day Total			221,32	85,36	316,15				
			70,00%	27,00%	100%				



XX. HUNGARIAN BAJA

MOTO

Stage 2		2022.08.12. SATURDAY / SZOMBAT						
Sunrise	5:30						20:15	Sunset
IE/TC	Location	SS Maximum Time	SS Km	Liasion Km	Total Km	Target Time	1st vehicle Due	
TC2D	Parc Fermé OUT						8:00	
<i>Refueling, Petrol Station,</i>								
TC3	Újmajor			29,81	29,81	0:45	8:45	
DSS 3A	START					0:05	8:50	
ASS 3A	FINISH	1:30	58,30		88,11	(0:47)	(9:37)	
<i>Gyulafirátót (Expected time of arrival)</i>								
Neutralization zone								
<i>Gyulafirátót</i>								
				1,38	89,49	0:15	9:52	
DSS 3B	START						9:52	
ASS 3B	FINISH	1:40	64,50		153,99	(0:51)	(10:43)	
<i>Várpalota (Expected time of arrival)</i>								
TC3A	Service IN			3,95	157,94	0:10	10:53	
SERVICE / SZERVIZ D								
TC3B	Service OUT			0,83	158,77	0:40	11:33	
<i>Refueling, Petrol Station,</i>								
TC3C	Regrouping IN			0,51	159,28	0:20	11:53	
REGROUPING								
TC3D	Regrouping OUT						12:15	
TC4	Újmajor			29,81	189,09	0:45	13:00	
DSS 4A	START					0:05	13:05	
ASS 4A	FINISH	1:30	58,30		247,39	(0:47)	(13:52)	
<i>Gyulafirátót (Expected time of arrival)</i>								
Neutralization zone								
<i>Gyulafirátót</i>								
				1,38	248,77	0:15	14:07	
DSS 4B	START						14:07	
ASS 4B	FINISH	1:40	64,50		313,27	(0:51)	(14:58)	
<i>Várpalota (Expected time of arrival)</i>								
TC4A	Parc Ferme IN / Early Check-IN is Authorised			3,95	317,22	0:15	15:13	
Day Total			245,60	71,62	317,22			
			77,42%	22,58%	100%			

Section 4

Section 5

	SS km	Liasion km	Total km
Rally Total	466,92	156,98	633,37
	73,72%	24,78%	100%

Appendix 2_Competers Relation Officer



(ENG + DEU + HUN)
Mr. István MÁTRAI
+36 20 417 6249

Estimated working plan:

Thursday 10. August	Admin check Scrutineering Briefing / Start TC / Start Ceremony	08:00 – 15:00 08:00 – 18:00 19:00 – 21:00
Friday 11. August	Parc Fermé / Service area	08:30 – 22:30
Saturday 12. August	Parc Fermé / Service area Finish Ceremony	08:30 – 18:00 19:00

Appendix 3_ Instruction for the installing and use of the GPS Tracking System



MAIN SCREEN

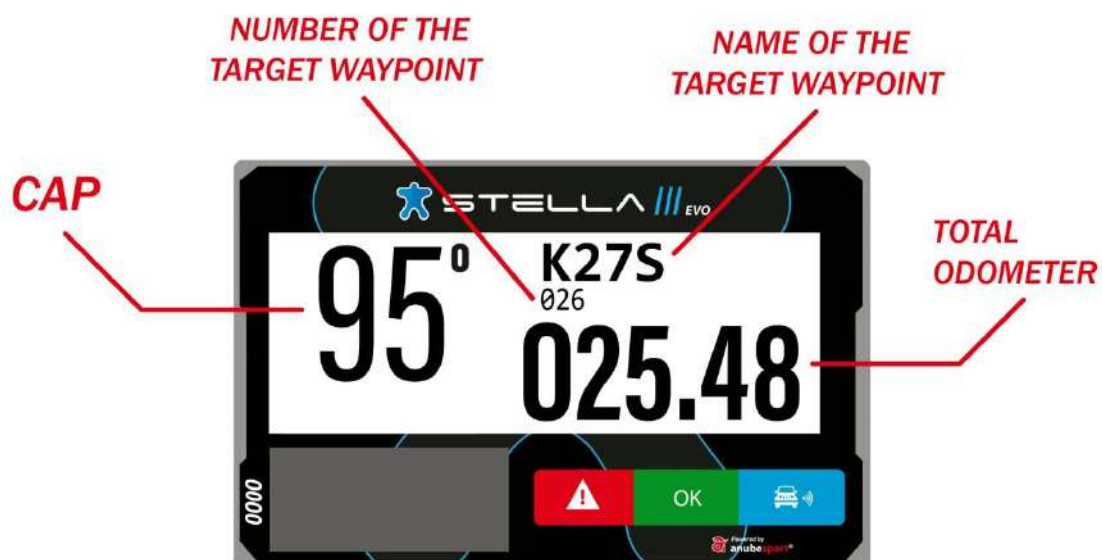

WAYPOINT PROXIMITY



SPEED ZONE

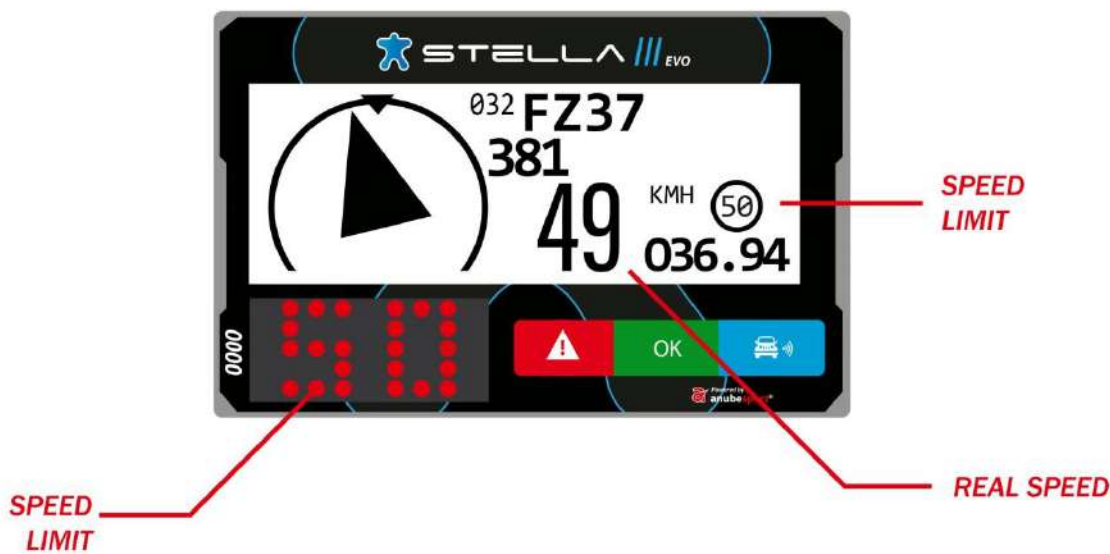

REQUEST MEDICAL ATTENTION IMMEDIATELY



SOS

1 sec.



CAUTION VEHICLE STATIONARY



3 sec.
BREAKDOWN



DANGER 3 !!!



Notification 300m before an area marked in the roadbook as "Danger 3"

OVERTAKING / BLUE FLAG



OVERTAKING / BLUE FLAG



STEADY



FLASHING



OVERTAKING / BLUE FLAG



FREE TO OVERTAKE



STEADY

PRESS THE BLUE BUTTON TO CONFIRM

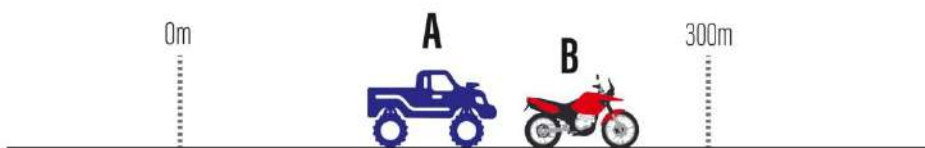

SPEED LIMIT



SPEED LIMIT

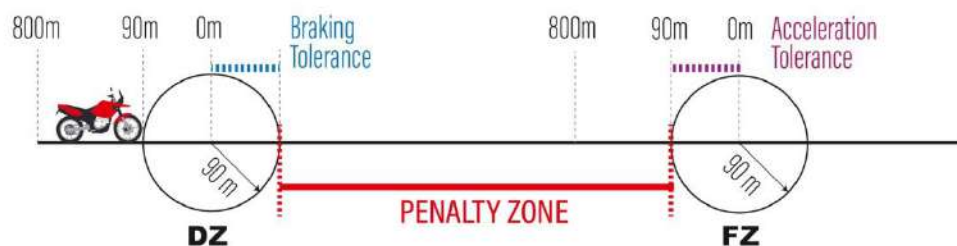

SPEED LIMIT



RED STEADY Inside of speed zone
RED FLASHING Overspeed

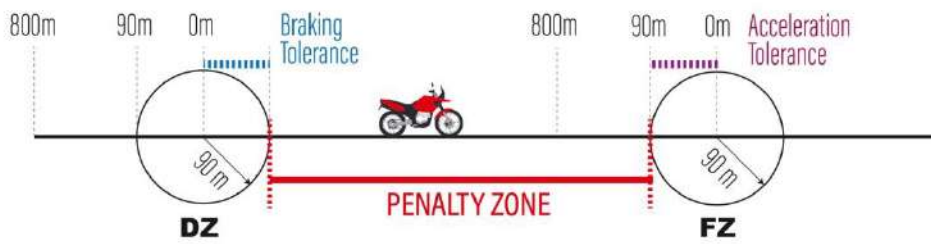

SPEED LIMIT



OFF end of speed zone

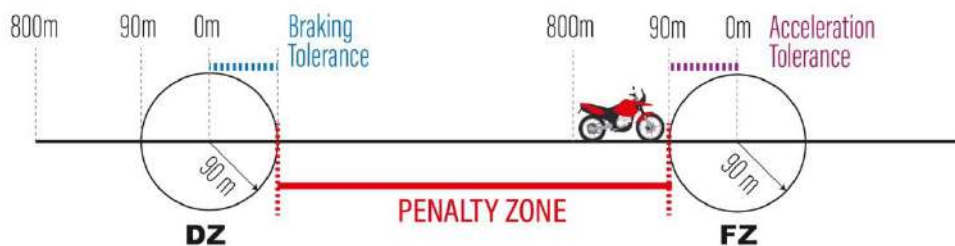

NEUTRALIZATION ZONE

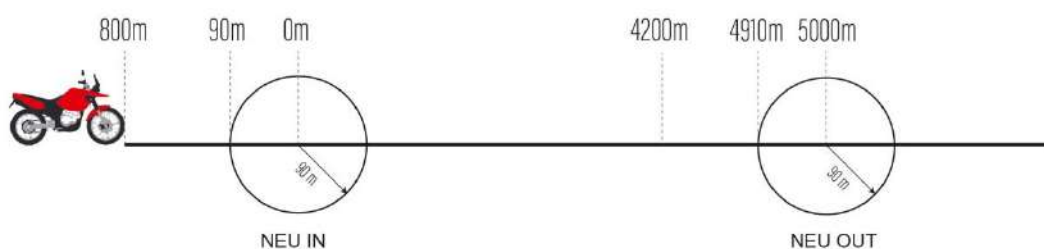

NEUTRALIZATION ZONE

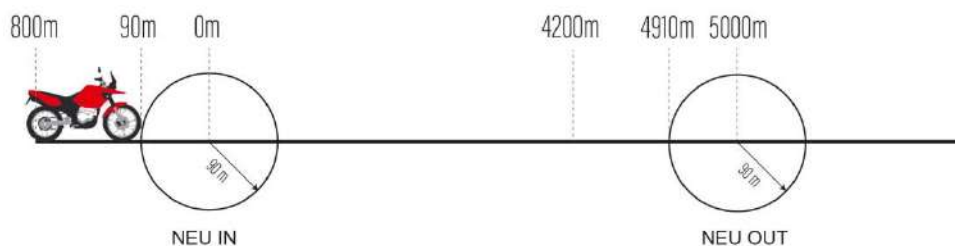

NEUTRALIZATION ZONE

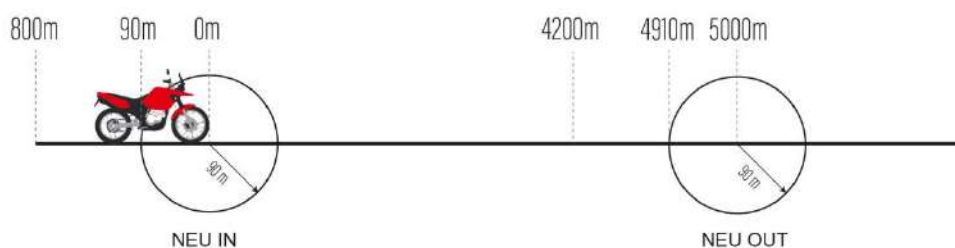

NEUTRALIZATION ZONE

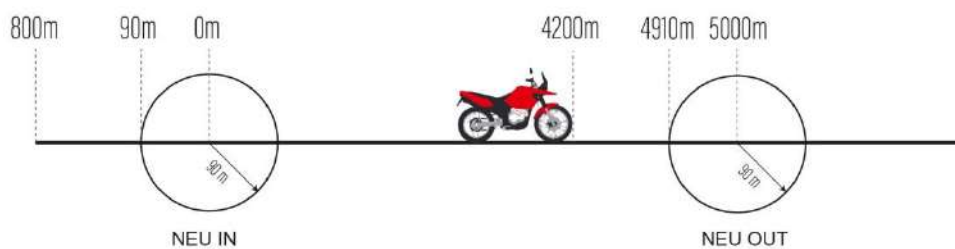

NEUTRALIZATION ZONE

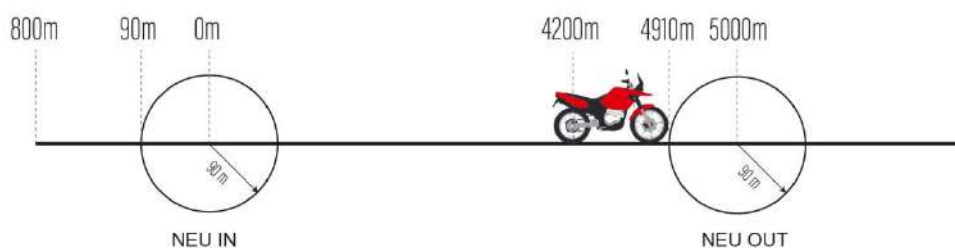

NEUTRALIZATION ZONE

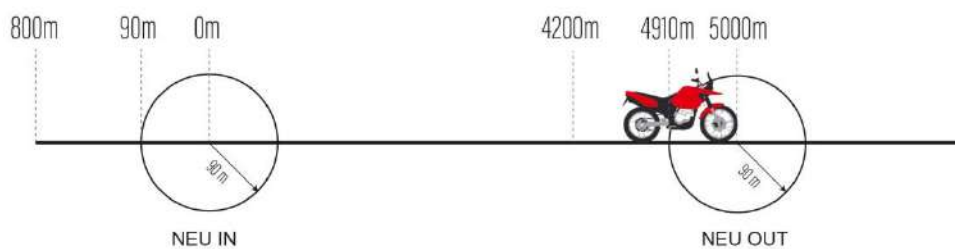

MESSAGES



WAYPOINTS LIST



TOTAL ODOMETER RESET TO ZERO



OK

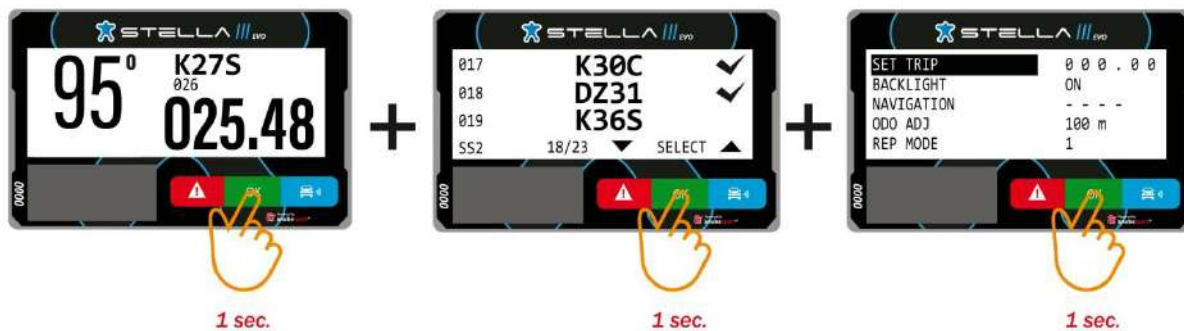

Appendix 3_ GPS Installation KIT

KIT COMPONENTS

80 €



1. Iridium Antenna
2. Power Cord
3. RF Cord
4. RF Antenna
5. Base/Mount
6. GPS Antenna
7. Adhesive
8. Straps
9. User Manual

IMPORTANT

For the functional tests and verification, all vehicles must have gone through the installation of the mount, power cord, and antennas.

1. POWER CORD

- Connect the red wire to the positive end of the battery 12V(+), and the grey wire to the negative end (GRD). The power cord must be connected directly to the battery (without interruptions and without contact in the power supply).
- A 3A fuse (not included) should be connected to the red wire.
- Take the cord to the location in which the STELLA III EVO is to be installed. All other wires must be insulated, they cannot touch.



2. BASE/MOUNT

- Motorcycles and ATV: The mount can be attached to the handle bar or to a metal plaque close to the navigation system.
- Cars and UTV: The mount can be attached to the panel, or to the roll cage bars. STELLA III EVO buttons must be visible and accessible to the participant (pilot/navigator) even when they are sitting and with the seatbelts buckled.

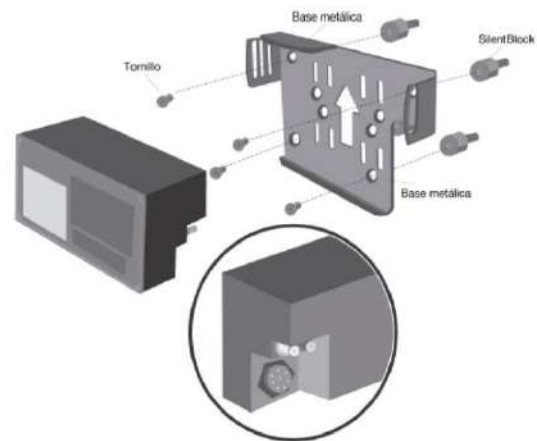

IMPORTANT

Leave the cords (antenna and battery) in place with at least 10 cm to spare for easy handling.

At least 5 cm of space behind the mount (bottom right corner) to allow space for power cord/connections.

3. GPS ANTENNA

The GPS antenna must be installed horizontally and without obstructions toward the sky. In cars and UTV, It can be mounted on the roof, the hood, or the dashboard. In motorcycles and ATV, attach to the mudguard. For additional firmness, it is recommended to cover it with adhesive tape (non metallic when mounting it to a metallic surface) and pull-up (when attached to soft or plastic parts).



4. ANTENNA IRIDIUM

The Iridium antenna must be installed horizontally and without obstructions toward the sky. In cars and UTV, It can be mounted on the roof, the hood, or the dashboard. In motorcycles and ATV, attach to the mudguard. For additional firmness, it is recommended to cover it with adhesive tape (non metallic when mounting it to a metallic surface) and pull-up (when attached to soft or plastic parts).



5. RF ANTENNA

The radio-frequency antenna must be installed vertically to the roll cage bars (cars and UTV) and the forks (motorcycles and ATV). It is mandatory to use separators (included in the kit) to avoid contact with metallic parts and the carbon fibre that surrounds it.

Once the antennas are mounted, take the SMA connection cords to the base/mount where the STELLA III EVO will be installed.



Appendix 5_ ITEMS AT THE ORGANISERS' DISCRETION

After the Prize Giving Ceremony, we are delighted to announce that a jubilee party will be held in celebration of the XX-th Hungarian Baja, and we warmly invite everyone to join us. We kindly recommend making accommodation arrangements accordingly.

We wish everyone a safe and accident-free competition!